





About AmerCareRoyal

AmerCareRoyal provides a comprehensive disposable product portfolio for the foodservice, janitorial, sanitation, industrial, hospitality and medical industries.

Our deep relationships with a diverse global supplier network and an established quality control infrastructure provide us with an unmatched ability to meet and exceed customer expectations.

Since 1949, our people first philosophy and higher business standards continue to strengthen our longstanding relationships with our global team and customers.

With distribution centers located strategically across the U.S. and Canada, we deliver customized solutions with expedited shipping and exceptional services to support our customers' needs.



PrimeWare® — READY. SET. GO GREEN.

PrimeWare® by AmerCareRoyal is a line of eco-friendly products, many of which are BPI-Certified compostable. Our disposable cups, plates, carriers, trays and containers are made from sustainable paper, sugarcane bagasse or bamboo fiber. PrimeWare lids, straws and cutlery are made from either compostable materials or fully recyclable PET.

PrimeWare compostables meet FDA guidelines for food service contact, are tested using ASTM D6400 guidelines and meet Health Canada guidelines for foodservice disposables. Delivered with efficient, dependable service, PrimeWare has eco-friendly, environmentally responsible disposables ready when you need them.

TABLE OF CONTENTS



Cutlery

Pages: 3-14



Disposable Bags

Pages: 15-22



Disposable Cups

Pages: 23-30



Fry Oil Filtration

Pages: 31-36



Gloves

Pages: 37-58

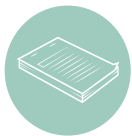

Guest Checks & Register Rolls

Pages: 59-68



Headwear & Hair Restraints

Pages: 69-76



Kids' Products

Pages: 77-80



Napkins

Pages: 81-90



Picks & Skewers

Pages: 91-96



Protective Wear

Pages: 97-106

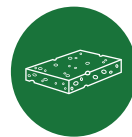

Scouring Pads

Pages: 107-114



Straws

Pages: 115-122



Take Out

Pages: 123-140

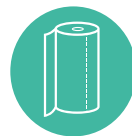

Towels & Wipes

Pages: 141-144



Miscellaneous

Pages: 145-152



PrimeWare







































Pages: 153-164



Index

Pages: 165-174

ICON MASTER KEY

	Adjustable Headband		Dietary		Hot & Cold Food
	Ambulance		Dishwasher Safe		Hospital
	American Society for Testing and Materials		Doctor's Office		Ink/Printing
	Automotive		ERs		Janitorial Category
	Back of the House Category		Exam Grade		Janitorial
	Beauty Supply		FDA Certification		Laboratory
	Biodegradable Item		Fentanyl Approved		Latex Free Item
	BPA Free Item		Food Safe		Leak-Resistant
	Catering		Foodservice		Lightly Powdered
	Chemotherapy Approved		Freezer Safe <small>+10°C / +14°F</small>		Made in the USA
	Compostable Item		Front of the House Category		Manage Waste
	Customizable Item		Heat Safe <small>+110°C / +230°F</small>		Microwave Safe
	Dentist		High Risk Medical Environments		Nursing Home



One Piece Design



Safety/First Aid



Temperature Instructions



Kosher

OU Kosher Certification



**Safety
and
Industrial**

Safety & Industrial
Category



Textured



Painting



School



USDA

USDA Certification



PrimeWare Eco Products



**SEPTIC
SAFE**

Septic Safe Item



**UV
TREATED**

UV Treated Item



PF

Powder Free



**BPI
COMPOSTABLE**

BPI Certified
Commercially Compostable
Product



Various Sizes



Recyclable



Tattoo



YouTube Video





CUTLERY

From picnics to cafeteria lunches to on-the-go, AmerCareRoyal has a large selection of cutlery for every need. Select from various compositions, weights, lengths and colors. Cutlery kits, serving utensils and accessories also available.

Medium Weight Cutlery	5
Medium Heavy Weight Cutlery	6
Heavy Weight Cutlery	7
Extra Heavy Weight Cutlery	10
Meal Kits	11
Environmental Cutlery	13
Serving Utensils & Miscellaneous	14



Cutlery

Medium Weight Polypropylene Cutlery

- Made from medium weight polypropylene
- Durable, economical cutlery option
- Great for casual dining and light meals



Series	Item	Color	Wrapped	Pack	Weight	Cube
P1203 Fork	P1203B	●		1/1000	5.9 lbs	0.45
	P1203FB	●	✓	1/1000	7.1 lbs	0.69
	P1203FW	○	✓	1/1000	6.8 lbs	0.64
	P1203W	○		1/1000	5.9 lbs	0.43
P2203 Teaspoon	P2203B	●		1/1000	5.6 lbs	0.37
	P2203FB	●	✓	1/1000	7.6 lbs	0.59
	P2203FW	○	✓	1/1000	7.2 lbs	0.58
P3203 Knife	P2203W	○		1/1000	5.9 lbs	0.36
	P3203B	●		1/1000	6.0 lbs	0.57
	P3203FB	●	✓	1/1000	6.4 lbs	0.38
P4203 Soup Spoon	P3203FW	○	✓	1/1000	6.2 lbs	0.47
	P3203W	○		1/1000	5.9 lbs	0.33
	P4203B	●		1/1000	5.9 lbs	0.40
	P4203FB	●	✓	1/1000	6.5 lbs	0.66
P5203 Spork	P4203FW	○	✓	1/1000	6.7 lbs	0.65
	P4203W	○		1/1000	5.9 lbs	0.40
	P5203FB	●	✓	1/1000	6.8 lbs	0.63
	P5203FW	○	✓	1/1000	6.6 lbs	0.62
	P5203W	○		1/1000	5.9 lbs	0.39



Medium Heavy Weight Cutlery

- Made from medium heavy weight polypropylene or polystyrene
- Constructed to provide nice grip
- Break resistant and designed to bend instead of shatter when applying force
- Great for take-out meals and school lunches

Series	Item	Color	Material	Wrapped	Pack	Weight	Cube
S1308 Fork	S1308B	●	PS		1/1000	7.1 lbs	0.50
	S1308FB	●	PS	✓	1/1000	8.4 lbs	0.71
	S1308FW	○	PS	✓	1/1000	8.0 lbs	0.78
	S1308W	○	PS		1/1000	7.2 lbs	0.54
P1405 Fork	P1405B	●	PP		1/1000	8.3 lbs	0.64
	P1405FB	●	PP	✓	1/1000	10.1 lbs	0.89
	P1405FW	○	PP	✓	1/1000	9.5 lbs	0.87
	P1405W	○	PP		1/1000	8.9 lbs	0.61
S2308 Teaspoon	S2308B	●	PS		1/1000	7.0 lbs	0.49
	S2308FB	●	PS	✓	1/1000	7.7 lbs	0.81
	S2308FW	○	PS	✓	1/1000	8.0 lbs	0.86
	S2308W	○	PS		1/1000	7.2 lbs	0.52
P2405 Teaspoon	P2405B	●	PP		1/1000	8.7 lbs	0.49
	P2405FB	●	PP	✓	1/1000	10.9 lbs	0.69
	P2405FW	○	PP	✓	1/1000	9.0 lbs	0.76
	P2405W	○	PP		1/1000	9.6 lbs	0.51
S3308 Knife	S3308B	●	PS		1/1000	7.7 lbs	0.41
	S3308FB	●	PS	✓	1/1000	8.4 lbs	1.04
	S3308FW	○	PS	✓	1/1000	8.2 lbs	0.66
	S3308W	○	PS		1/1000	7.7 lbs	0.43
P3405 Knife	P3405B	●	PP		1/1000	8.9 lbs	0.47
	P3405FB	●	PP	✓	1/1000	10.1 lbs	0.70
	P3405FW	○	PP	✓	1/1000	9.8 lbs	0.74
	P3405W	○	PP		1/1000	8.9 lbs	0.47
S4308 Soup Spoon	S4308B	●	PS		1/1000	7.0 lbs	0.53
	S4308FB	●	PS	✓	1/1000	7.7 lbs	0.74
	S4308W	○	PS		1/1000	7.0 lbs	0.53
P4405 Soup Spoon	P4405B	●	PP		1/1000	9.2 lbs	0.58
	P4405FB	●	PP	✓	1/1000	10.9 lbs	0.83
	P4405FW	○	PP	✓	1/1000	10.9 lbs	0.83
	P4405W	○	PP		1/1000	9.6 lbs	0.54



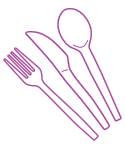

Cutlery



Heavy Weight Polypropylene Cutlery

- Made from heavy weight polypropylene
- Strong, durable and shatter resistant
- Constructed for a nice grip and flexible strength
- Perfect cutlery for upscale take-out

Series	Item	Color	Wrapped	Pack	Weight	Cube
P1505 Fork	P1505B	●		1/1000	12.6 lbs	0.683
	P1505FB	●	✓	1/1000	13.4 lbs	1.661
	P1505FW	○	✓	1/1000	13.7 lbs	0.918
	P1505W	○		1/1000	11.4 lbs	0.687
P2505 Teaspoon	P2505B	●		1/1000	9.9 lbs	0.57
	P2505FB	●	✓	1/1000	10.9 lbs	0.869
	P2505FW	○	✓	1/1000	10.9 lbs	0.809
	P2505W	○		1/1000	9.8 lbs	0.84
P3505 Knife	P3505B	●		1/1000	11.3 lbs	0.531
	P3505FB	●	✓	1/1000	14.1 lbs	0.782
	P3505FW	○	✓	1/1000	12.9 lbs	0.767
	P3505W	○		1/1000	11.7 lbs	0.515
P4505 Soup Spoon	P4505B	●		1/1000	10.2 lbs	0.659
	P4505FB	●	✓	1/1000	12.3 lbs	0.919
	P4505FW	○	✓	1/1000	11.0 lbs	0.872
	P4505W	○		1/1000	11.0 lbs	0.65





Heavy Weight Polystyrene Cutlery

- Made from heavy weight polystyrene
- Great option for upscale dining
- Constructed for a nice grip, flexible strength and bend resistance
- Perfect for heavier meals



Series	Item	Color	Wrapped	Pack	Weight	Cube
S1601 Fork	S1601B	●		1/1000	11.0 lbs	0.63
	S1601C	⦿		1/1000	10.9 lbs	0.71
	S1601CH	●		1/1000	11.7 lbs	0.70
	S1601FB	●	✓	1/1000	12.3 lbs	1.14
	S1601FW	○	✓	1/1000	11.8 lbs	1.05
	S1601W	○		1/1000	11.1 lbs	0.66
S2601 Teaspoon	S2601B	●		1/1000	9.5 lbs	0.60
	S2601C	⦿		1/1000	9.4 lbs	0.64
	S2601CH	●		1/1000	9.8 lbs	0.81
	S2601FB	●	✓	1/1000	10.3 lbs	0.98
	S2601FW	○	✓	1/1000	10.3 lbs	0.94
	S2601W	○		1/1000	9.5 lbs	0.60
S3601 Knife	S3601B	●		1/1000	12.9 lbs	0.54
	S3601C	⦿		1/1000	12.8 lbs	0.54
	S3601CH	●		1/1000	12.6 lbs	0.58
	S3601FB	●	✓	1/1000	13.0 lbs	0.73
	S3601FW	○	✓	1/1000	13.0 lbs	0.76
	S3601W	○		1/1000	12.6 lbs	0.54
S4601 Soup Spoon	S4601B	●		1/1000	9.5 lbs	0.71
	S4601C	⦿		1/1000	8.9 lbs	0.67
	S4601CH	●		1/1000	9.6 lbs	0.71
	S4601FB	●	✓	1/1000	10.4 lbs	0.94
	S4601FW	○	✓	1/1000	10.3 lbs	0.93
	S4601W	○		1/1000	9.5 lbs	0.65





Cutlery



Heavy Weight Polystyrene Retail Box

Series	Item	Color	Per Box	Pack	Weight	Cube
S1601 Fork	S1601XC	☼	100	10/100	12.2 lbs	0.85
	S1601XCH	●	100	10/100	12.5 lbs	0.87
	S1601XW	○	100	10/100	12.4 lbs	0.87
S2601 Teaspoon	S2601XC	☼	100	10/100	10.2 lbs	0.69
	S2601XCH	●	100	10/100	10.2 lbs	0.66
	S2601XW	○	100	10/100	11.4 lbs	0.70
S3601 Knife	S3601XC	☼	100	10/100	13.9 lbs	0.61
	S3601XCH	●	100	10/100	14.4 lbs	0.61
	S3601XW	○	100	1/1000	13.9 lbs	0.62
S4601 Soup Spoon	S4601XC	☼	100	10/100	10.6 lbs	0.76
	S4601XCH	●	100	10/100	12.8 lbs	0.77
	S4601XW	○	100	10/100	10.9 lbs	0.74
S601 Bulk Pack	S601RPC	☼	180 Forks 120 Spoons 60 Knives	4/360	22 lbs	1.09



Extra Heavy Weight Polystyrene Cutlery

- Strongest and most heavy duty cutlery
- Constructed with an excellent grip
- Durable enough to withstand heavy foods including meat
- Perfect for catering, restaurants and take out

Series	Item	Color	Material	Wrapped	Pack	Weight	Cube
S1602 Fork	S1602B	●	PS		1/1000	15.0 lbs	0.56
	S1602CH	●	PS		1/1000	15.0 lbs	0.56
	S1602W	○	PS		1/1000	15.8 lbs	0.56
S1603 Fork	S1603B	●	PS		1/1000	13.0 lbs	0.55
	S1603C	⊗	PS		1/1000	13.0 lbs	0.55
	S1603CH	●	PS		1/1000	13.0 lbs	0.55
	S1603FB	●	PS	✓	1/1000	13.2 lbs	0.55
	S1603W	○	PS		1/1000	9.5 lbs	0.55
S2602 Teaspoon	S2602B	●	PS		1/1000	9.8 lbs	0.60
	S2602CH	●	PS		1/1000	9.8 lbs	0.60
	S2602W	○	PS		1/1000	9.8 lbs	0.60
S2603 Teaspoon	S2603C	⊗	PS		1/1000	9.5 lbs	0.49
	S2603FB	●	PS	✓	1/1000	9.8 lbs	0.83
	S2603W	○	PS		1/1000	9.5 lbs	0.49
S3602 Knife	S3602B	●	PS		1/1000	16.8 lbs	0.54
	S3602CH	●	PS		1/1000	16.8 lbs	0.54
	S3602W	○	PS		1/1000	16.8 lbs	0.54
S3603 Knife	S3603B	●	PS		1/1000	15.0 lbs	0.53
	S3603C	⊗	PS		1/1000	15.0 lbs	0.53
	S3603CH	●	PS		1/1000	15.0 lbs	0.53
	S3603FB	●	PS	✓	1/1000	19.5 lbs	0.81
	S3603W	○	PS		1/1000	15.0 lbs	0.53
S4602 Soup Spoon	S4602B	●	PS		1/1000	13.0 lbs	0.60
	S4602FB	●	PS	✓	1/1000	13.7 lbs	0.73
S4603 Soup Spoon	S4603B	●	PS		1/1000	13.0 lbs	0.58
	S4603FB	●	PS	✓	1/1000	13.2 lbs	0.58





Cutlery



Meal Kits

- Perfect for on-the-go meals
- Offers customers the convenience of everything they need
- Wrapped kit contents include various combinations of fork, knife, spoon, napkin, salt and pepper, a spork or straw



Meal Kits

Series	Item	Color	Material	Strength	Fork	Knife	Teaspoon	Soup Spoon	Spork	Napkin	Salt	Pepper	Milk Straw	Pack	Weight	Cube	
2 Piece	2KP505B02	●	PP	H	✓	✓								1/1000	25.6 lbs	2.10	
	2KS308B	●	PS	MH	✓					✓				1/1000	15.4 lbs	1.82	
3 Piece	3KP203B500	●	PP	M	✓	✓	✓							1/500	9.6 lbs	1.17	
	3KP203W06	○	PP	M					✓	✓			✓	1/500	11.0 lbs	1.36	
	3KP203W07	○	PP	M	✓					✓			✓	1/1000	10.3 lbs	1.54	
	3KP203W500	○	PP	M	✓	✓	✓							1/250	8.9 lbs	1.20	
	3KP401B500	●	PP	MH	✓	✓				✓				1/250	12.1 lbs	1.21	
	3KP505B	●	PP	H	✓	✓	✓							1/500	9.2 lbs	0.92	
	3KS308B01	●	PS	MH	✓	✓					✓			1/500	10.7 lbs	1.32	
	3KS601B02	●	PS	H	✓	✓					✓			1/1000	15.7 lbs	1.49	
	3KS601W05	○	PS	H	✓						✓			✓	1/1000	19.4 lbs	2.13
	4KP203B05	●	PP	M	✓	✓	✓				✓				1/200	5.4 lbs	0.73
4 Piece	4KP203B09	●	PP	M	✓	✓		✓		✓				1/1000	13.6 lbs	1.44	
	4KP203W05	○	PP	M	✓	✓	✓			✓				1/250	5.9 lbs	0.74	
	4KP203W06	○	PP	M					✓	✓	✓	✓		1/250	11.5 lbs	1.21	
	4KP203W14	○	PP	M	✓		✓			✓			✓	1/250	8.5 lbs	1.24	
	4KP405B	●	PP	MH	✓	✓	✓			✓				1/500	16.1 lbs	1.62	
	4KP505B01	●	PP	H	✓	✓	✓			✓				1/500	10.8 lbs	1.02	
	4KS601B02	●	PS	H	✓	✓		✓		✓				1/500	10.6 lbs	1.09	
5 Piece	5KP203B03	●	PP	M	✓	✓				✓	✓	✓		1/250	9.7 lbs	1.12	
	5KP203W02	○	PP	M	✓	✓				✓	✓	✓		1/500	5.3 lbs	0.56	
	5KP203W04	○	PP	M	✓		✓			✓	✓	✓		1/500	4.6 lbs	0.54	
	5KP405B	●	PP	MH	✓	✓				✓	✓	✓		1/500	13.9 lbs	1.37	
	5KP505B	●	PP	H	✓	✓				✓	✓	✓		1/250	18.8 lbs	1.74	
	5KS308B03	●	PS	MH	✓	✓					✓	✓	✓	1/500	14.4 lbs	1.83	
6 Piece	6KP203B	●	PP	M	✓	✓	✓			✓	✓	✓		1/250	6.6 lbs	0.74	
	6KP203W	○	PP	M	✓	✓	✓			✓	✓	✓		1/250	6.6 lbs	0.74	
	6KP302B	●	PP	M+	✓	✓	✓			✓	✓	✓		1/250	7.5 lbs	0.73	
	6KP302W	○	PP	M+	✓	✓	✓			✓	✓	✓		1/250	8.4 lbs	0.67	
	6KP405B	●	PP	MH	✓	✓		✓		✓	✓	✓		1/250	8.7 lbs	1.01	
	6KP505B	●	PP	H	✓	✓	✓			✓	✓	✓		1/250	11.9 lbs	1.19	
	6KP505W	○	PP	H	✓	✓	✓			✓	✓	✓		1/250	12.2 lbs	1.24	
	6KS308B	●	PS	MH	✓	✓	✓			✓	✓	✓		1/250	7.3 lbs	0.81	
	6KS308W	○	PS	MH	✓	✓	✓			✓	✓	✓		1/250	7.3 lbs	0.81	
	6KS601B	●	PS	H	✓	✓	✓			✓	✓	✓		1/250	11.0 lbs	1.09	
	6KS601C01	⊗	PS	H	✓	✓	✓			✓	✓	✓		1/250	11.0 lbs	1.09	
	6KS601W	○	PS	H	✓	✓	✓			✓	✓	✓		1/250	10.9 lbs	1.10	



Cutlery

CPLA Cutlery



- Made from renewable CPLA or modified corn-based plastic
- Ideal for both hot and cold foods
- FDA approved for food contact and ASTM compliant
- Compostable



Cutlery	Item	Color	Pack	Weight	Cube
Fork	BCPW-F*	●	20/50	11.5 lbs	0.45
	CPW-F*	○	20/50	12.3 lbs	0.53
Knife	BCPW-K*	●	20/50	11.5 lbs	0.36
	CPW-K*	○	20/50	11.4 lbs	0.48
Spoon	BCPW-S*	●	20/50	13.8 lbs	0.51
	CPW-S*	○	20/50	14.1 lbs	0.58
3pc Kit Fork, Knife, Spoon	WCPW-KIT	○	1/500	8.4 lbs	0.68



Wood Cutlery

- Give the convenience of disposable cutlery but in a stylish, eco-friendly design
- Ideal for both hot and cold foods
- Made of strong, 100% natural birch wood
- Made with no coatings, bleach or dye, making wood cutlery biodegradable and compostable

Cutlery	Item	Color	Pack	Weight	Cube
Fork	WF1000	●	20/50	7.0 lbs	0.28
Knife	WK1000	●	20/50	7.0 lbs	0.23
Spoon	WS1000	●	20/50	11.5 lbs	0.36

Plant Starch Cutlery



- Made from plant starch material, produced from corn and potato starch
- Ideal for both hot and cold foods
- Water and oil proof
- Made from 80% PSM and 20% polypropylene materials, not compostable
- FDA approved for food contact



Cutlery	Item	Color	Pack	Weight	Cube
Fork	BPWF-7	●	20/50	14.9 lbs	0.80
	PWF-7	○	20/50	14.9 lbs	0.80
Knife	BPWK-7	●	20/50	14.9 lbs	0.74
	PWK-7	○	20/50	14.9 lbs	0.74
Spoon	BPWS-7	●	20/50	14.9 lbs	0.74
	PWS-7	○	20/50	14.9 lbs	0.75
Soup Spoon	BPWSS-7	●	20/50	16.7 lbs	0.67
	PWSS-7	○	20/50	16.7 lbs	0.67

Wheat Cutlery

- Made from a 40% wheat composition
- As strong as heavyweight plastic cutlery
- Gluten-free and leaves a smaller carbon footprint than polypropylene and polystyrene cutlery
- Great option for cafes, catering events, restaurants, or coffee shops



Cutlery	Item	Color	Pack	Weight	Cube
Fork	WP1601	●	1/1000	11.2 lbs	0.68
Teaspoon	WP2601	●	1/1000	9.2 lbs	0.60
Knife	WP3601	●	1/1000	12.3 lbs	0.52
Soup Spoon	WP4601	●	1/1000	9.2 lbs	0.66



PrimeWare
Sustainable Product



BPI Certified
Commercially Compostable Product



Serving Utensils

- Made from high-quality polystyrene; extra heavy weight material offers more durability than standard utensils
- Convenient disposable utensils, individually wrapped
- Great for large salads, pastas & more
- Perfect for catering, events and restaurants

Utensil	Item	Color	HW	Pack	Weight	Cube
Fork	S12001FB	●		1/144	6.8 lbs	0.37
	SXH12001FB	●	✓	1/144	7.1 lbs	0.40
Spoon	S42001FB	●		1/144	7.3 lbs	0.42
	SXH42001FB	●	✓	1/144	7.9 lbs	0.45
Tongs	S64001FB	●		1/48	3.1 lbs	0.43
	SXH64001FB	●	✓	1/48	5.2 lbs	0.31



ABS Heavyweight Knife

- Strong enough to cut steak, tough bread crusts or bacon.
- Made from heavyweight ABS plastic
- Feature sharp and smooth cutting edges and a modern and sleek design that won't crack or chip during meals

Item	Color	Pack	Weight	Cube
KABS1000	○	1/1000	21.7 lbs	0.86



Bamboo Chopsticks

Item	Sleeve Color	Pack	Weight	Cube
R809	●	10/100	16.1 lbs	0.73
R809TW	○	10/100	21.2 lbs	0.95

Specialty Cutlery

Item	Description	Color	Wrapped	Pack	Weight	Cube
P2103W	Ice Cream Spoon, Polypropylene	○		1/3000	6.9 lbs	0.49
P2303FB	Soda Spoon, Polypropylene	●	✓	1/1000	11.0 lbs	0.88
P2303W	Soda Spoon, Polypropylene	○		1/1000	9.4 lbs	0.63
R826	Two Prong Fork, Wood	●		10/1000	23.6 lbs	1.05
R832	Spoon, Wood	●		10/1000	20.9 lbs	0.78
R832W	Spoon, Wood	●	✓	10/1000	42.6 lbs	2.47
RPF325RD	3 Prong Fork, Plastic	●		1/2500	15.0 lbs	0.90
RTS3000	Taster Spoon, Plastic	○		1/3000	8.8 lbs	0.48
S2303W	Soda Spoon, Polystyrene	○		1/1000	9.2 lbs	0.64







DISPOSABLE BAGS & ACCESSORIES

AmerCareRoyal has the right kind of disposable bags to accommodate your needs. Choose from a variety of bun pan bags and steam pan liners that will keep your food fresh and reduce prep time. We also feature a selection of food storage bags to make food preparation as simple as can be.

High Heat Oven Bags.....	17
Steam Pan Liners.....	17
Bun Pan Bags.....	17
Food Storage Bags.....	19
Plastic Mesh Bags.....	21
Food Rotation Labels.....	22



Disposable Bags



ORB3426 & SPL1814

High Heat Oven Bags & Pan Liners

Our high temperature nylon oven bags and pan liners save cooking and cleaning time while increasing profitability. These bags are made from heat resistant nylon and are completely safe for use in the oven, microwave, slow cooker and steamer at temperatures up to 400 degrees F. Since there is no direct metal-to-food contact, our pan liners prevent baked-on food from sticking. They also eliminate the need for heavy cleaning of pans while reducing waste from dried-out or burned-on foods.





BPB2135

High Heat Oven Bags & Pan Liners

- No more wasting time scrubbing pans
- Easily sanitize pan after removing the liner or bag
- Reduce waste and make clean up a breeze
- Help to prevent cross contamination
- Available in a variety of sizes to fit standard pans

Series	Item	Pan Size	Dimensions	Pack	Weight	Cube
High Heat Oven Bags with Ties	ORB1824	11 Quart Pan	18" x 24"	1/100	4.4 lbs	0.26
	ORB2418	Medium Pan	24" x 18"	1/100	4.4 lbs	0.26
	ORB3426	Turkey Pan	34" x 26"	1/50	4.5 lbs	0.26
Steam Pan Liners	SPL3425	Full	34" x 25"	1/250	10.2 lbs	0.37
	SPL2417	1/2	23½" x 17"	1/250	4.9 lbs	0.18
	SPL1814	1/4 or 1/3	18" x 14"	1/250	3.2 lbs	0.10
	SPL1215	1/6	12" x 15"	1/500	4.4 lbs	0.16
High Heat Soup Pan Liners	OPL1820	9 & 11 Quart	18" x 20"	1/100	3.8 lbs	0.26
	OPL1515	6 or 7 Quart	15" x 15"	1/100	2.7 lbs	0.26
	OPL1215	4 Quart	12" x 15"	1/100	2 lbs	0.16

High Heat Pan Liners

- No more wasting time scrubbing pans
- Simply sanitize pan removing the liner
- Reduces risk of food contamination

Item	Pan Size	Dimensions	Pack	Weight	Cube
OPL3418	Deep Full	34" x 18"	1/50	3.4 lbs	0.26
OPL3412	Shallow Full	34" x 12"	1/100	4.3 lbs	0.26
OPL2314	Deep 1/2	23" x 14"	1/100	3.5 lbs	0.26
OPL2028	Bun	20½" x 28½"	1/100	3.2 lbs	0.26
OPL1914	1/3 or 1/4	19" x 14"	1/100	3.1 lbs	0.26

Bun Pan Bags

- Designed to keep dough fresh
- Smooth, easy perforated roll pack dispensing
- Low density polyethylene

Item	Dimensions	Pack	Weight	Cube
BRC5280	52" x 80"	1/50	9 lbs	0.34
BPB2737	27" x 37"	1/200	9.7 lbs	0.31
BPB2135	21" x 6" x 35"	1/200	13.8 lbs	0.67



Disposable Bags



Food Storage Bags

AmerCareRoyal's high quality bags are ideal for all your food storage needs. From proportioning to storing to packaging, our line of high quality food bags make food storage easy. Offered in low-density and high-density polyethylene, these food storage bags meet FDA requirements for food applications. Functional packaging designs allow for smooth dispensing in both flat pack and roll pack options.

High Density Food Storage Bags

- High tensile strength that prevents rips and tears
- Protects to keep food fresh
- Clear bag for easy recognition of contents
- Perfect to store almost any kind of food in freezers or refrigerator

Item	Bag Type	Dimensions	Dispense	Thickness	Pack	Weight	Cube
FTS66	Sandwich Flip Top	6½" x 6"	Flat Pack	15 mic	1/2000	4.0 lbs	0.13
FSD69	Food Storage	6½" x 9"	Roll Pack	16 mic	1/2000	5.3 lbs	0.15
FSD1014	Food Storage	10" x 14"	Roll Pack	16 mic	1/1000	6.2 lbs	0.21
FSD1824	Food Storage	18" x 24"	Roll Pack	16 mic	1/250	4.9 lbs	0.24
BPB2737	Bun Pan	27" x 37"	Roll Pack	16 mic	1/200	9.7 lbs	0.31



Low Density Food Storage Bags

- Protects and keeps food fresh
- Clear bag for easy recognition of contents
- Variety of sizes makes our food storage bags great for proportioning

Item	Bag Type	Dimensions	Dispense	Thickness	Pack	Weight	Cube
FSLD48	Food Storage	4" x 2" x 8"	Roll Pack	0.6 mil	1/1000	2.4 lbs	0.08
FSLD615	Food Storage	6" x 3" x 15"	Roll Pack	0.6 mil	1/1000	5.9 lbs	0.34
FSLD69	Food Storage	6½" x 9"	Roll Pack	0.6 mil	1/2000	5.4 lbs	0.17
FTS77	Sandwich Flip Top	7" x 7"	Flat Pack	0.7 mil	1/2000	6.3 lbs	0.19
FSLD818	Food Storage	8" x 4" x 18"	Roll Pack	0.8 mil	1/1000	11.9 lbs	0.48
FSLD1024	Food Storage	10" x 8" x 24"	Roll Pack	1 mil	1/200	6.3 lbs	0.29
FSLD1014	Food Storage	10" x 14"	Roll Pack	0.8 mil	1/1000	7.9 lbs	0.36
FSLD1824	Food Storage	18" x 24"	Roll Pack	0.8 mil	1/250	6.1 lbs	0.34
BPB2135	Bun Pan	21" x 6" x 35"	Roll Pack	1 mil	1/200	13.8 lbs	0.67

Silverware Bag

Item	Dimensions	Dispense	Thickness	Pack	Weight	Cube
SWB310	3½" x 10"	Flat Pack	N/A	1/2000	2.8 lbs	0.16

Saddle Bags

- Great choice to keep portioned foods from being cross contaminated
- Choose from printed or non-printed options

Item	HD	LD	Deli	Printed	Zip Seal	Dispensing Rack	Material	Dimensions	Thickness	Pack	Weight	Cube
SB55	✓						HDPE	5½" x 5½"	15 mic	1/2000	3.2 lbs	0.17
SB67	✓						HDPE	6½" x 7"	15 mic	1/2000	4.9 lbs	0.22
SB85DP	✓		✓	✓			HDPE	8½" x 8½"	15 mic	1/2000	8.2 lbs	0.68
SB85	✓		✓				HDPE	8½" x 8½"	15 mic	1/2000	8.2 lbs	0.44
SB1085	✓		✓				HDPE	10" x 8½"	N/A	1/2000	9.8 lbs	0.54
SB1085DPZ		✓	✓	✓	✓		LDPE	10" x 8½"	1.4 mil	1/1000	10.8 lbs	0.80
RSBR						✓	Wire	N/A	N/A	1/1	1.2 lbs	0.29

Zip-it

- Double zipper provides extra sealed closure to keep food safe and fresh
- Made from durable low-density polyethylene
- Features two white blocks for writing dates or bag contents
- Available in various sizes and thicknesses

Item	Bag Type	Dimensions	Thickness	Pack	Weight	Cube
ZBS66	Sandwich	6½" x 6"	1.2 mil	1/500	2.7 lbs	0.10
ZBQ78	Quart	7" x 8"	1.75 mil	1/500	5.3 lbs	0.19
ZBG1011	Gallon	10½" x 11"	2 mil	1/250	4.9 lbs	0.16
ZBG1315	Two Gallon	13" x 15.6"	1.75 mil	1/100	3.2 lbs	0.13





Plastic Mesh Bags

- Makes boiling shellfish, marinating meats and carrying produce quick and easy
- Durable, quality bags are available in multiple colors and offer 100% breathability

Back
of house





Item	Color	Pack	Weight	Cube
LDRMB1000CL		1/1000	9.5 lbs	1.31
LDRMB1000A		1/1000	9.5 lbs	1.31
RMB1000Y		1/1000	9.6 lbs	1.31
RMB1000U		1/1000	9.6 lbs	1.31
RMB1000T		1/1000	9.6 lbs	1.31
RMB1000O		1/1000	9.6 lbs	1.31
RMB1000E		1/1000	9.6 lbs	1.31
RMB1000CL		1/1000	9.6 lbs	1.33
RMB1000C		1/1000	9.6 lbs	1.31
RMB1000BK		1/1000	9.6 lbs	1.31
RMB1000A		1/1000	9.6 lbs	1.31

Food Rotation Labels

- Reduce the risk of foodborne illness and cross contamination from freezer to shelf
- Allows users to mark when the food was prepared, when the food should be used by and when the food should be discarded
- Support inventory control while saving time and money
- Easy to use, universally color-coded and clear fields

Item	Dimensions	Pack	Weight	Cube
FRL23500	2" x 3"	1/24	16 lbs	0.41







DISPOSABLE CUPS

Whether you are looking for the perfect cup for on-the-go coffee, or a refreshing cold drink, AmerCareRoyal has the right cup for you! Various sizes and matching lids are available for all of our cup products.

PET Cold Cups & Lids	25
Paper Cold Cups & Lids	26
PLA Cold Cups & Lids	26
Paper Hot Cups & Lids	27
Cup Carriers	29
Coffee Sleeves	30
Coasters.....	30



Disposable Cups and Lids



On this page: TCE16 with TCEL1424

PET Cold Cups

- Made from PET plastic that provides excellent durability
- Perfect to-go option for cold beverages
- Matching lids available

PET Cold Cup Lids

Size	Item	Color	Flat	Dome	Pack	Weight	Cube
14oz-24oz	TCEL1424		✓		1/1000	8.1 lbs	1.8

PET Cold Cups

Size	Item	Color	Pack	Weight	Cube
14oz	TCE14		1/1000	30.1 lbs	3.17
16oz	TCE16		1/1000	35.2 lbs	3.19
20oz	TCE20		1/1000	35.2 lbs	3.16
24oz	TCE24		1/600	23.7 lbs	2.07





PrimeWare
Sustainable Product



PLA Cold Cups

- Made from PLA or corn-based plastic
- BPI certified compostable and meet ASTM D6400 for compostability
- Perfect cold beverages on the go

PLA Cold Cup Lids

Size	Item	Color	Flat	Dome	Pack	Weight	Cube
9oz	CFL-9		✓		10/100	6.2 lbs	1.5
12oz-	CFL-1224		✓		10/100	6.8 lbs	1.52
24oz	CDL-1224			✓	20/50	9.9 lbs	2.06

PLA Cold Cups

Size	Item	Color	Pack	Weight	Cube
9oz	CCP-9-SQ		20/50	19.4 lbs	2.57
12oz	CCP-12		20/50	23.6 lbs	3.04
16oz	CCP-16		20/50	28.9 lbs	3.59
20oz	CCP-20		20/50	37.3 lbs	4.19
24oz	CCP-24		12/50	20.5 lbs	2.52

Paper Cold Cups

- Poly coated paper cups
- Perfect for chilled or iced beverages on the go
- Matching lids available

Paper Cold Cup Lids

Size	Item	Color	Flat	Dome	Pack	Weight	Cube
12oz- 22oz	PCCLS1222	○	✓		1/2000	10.1 lbs	3.07

Paper Cold Cups

Size	Item	Color	Pack	Weight	Cube
12oz	PCC12	○	1/1000	19.8 lbs	5.5
16oz	PCC16	○	1/1000	25.3 lbs	5.5
22oz	PCC22	○	1/1000	32 lbs	5.5





Disposable Cups and Lids



On this page: HC-10 with HCL-1220

Paper Hot Cups

- Made from SFI certified paperboard and PLA or corn-based plastic lined
- Microwave and freezer safe
- Perfect for hot beverages on the go
- BPI certified compostable and meet ASTM D6400 for compostability
- Matching lids available



PrimeWare
Sustainable Product



BPI Certified
Commercially Compostable
Product

Disposable Cups and Lids

Check out our coffee stirrers on Page 122!



Paper Hot Cups  
Compostable Paper, PLA Lined

Size	Item	Color	Pack	Weight	Cube
4oz	HC-4*	○	20/50	10 lbs	1.11
8oz	HC-8*	○	20/50	21 lbs	2.26
	W-HC-8	○	20/50	21 lbs	2.26
10oz	HC-10*	○	20/50	23.6 lbs	2.73
12oz	HC-12*	○	20/50	28 lbs	3.23
	W-HC-12	○	20/50	28 lbs	3.23
16oz	HC-16*	○	20/50	33.1 lbs	3.82
	W-HC-16	○	20/50	33.1 lbs	3.82
20oz	HC-20*	○	20/50	36.4 lbs	4.01
	W-HC-20	○	20/50	36.4 lbs	4.01



Hot Cup Lids  

Size	Item	CPLA	Fiber	Color	Pack	Weight	Cube
8oz	CHCL-8*	✓		○	20/50	7.6 lbs	1.59
10oz - 20oz	CHCL-1020	✓		○	20/50	9.2 lbs	1.99
12oz - 20oz	HCL-1220*		✓	○	10/50	6.8 lbs	0.94







Disposable Cups and Lids



On this page: CC-1232

Cup Carriers

- Designed to hold both hot and cold cups ranging from 8 to 32 oz
- Disposable and compostable
- Various sizes available

Item	Cup Size	Cups	Color	Pack	Weight	Cube
CC-832	8-32 oz	4		4/75	24.4 lbs	2.59
CC-802	8-24 oz	2		10/50	29.4 lbs	2.81
CC-2CupTray	8-32 oz	2 + Tray		2/125	23.5 lbs	2.1
CC-1232	12-32 oz	4		4/75	29.3 lbs	2.81



PrimeWare
Sustainable Product

Cup Sleeves

- Protect customers' hands from hot beverages
- Designed to fit standard sized hot beverage cups
- Available in plain and printed styles
- Perfect for cafés, diners, restaurants, food trucks, catering and more

Item	Print	Color	Pack	Weight	Cube
ES1000N	No Print	●	10/100	10.4 lbs	1.02
ES1000	"Enjoy"	●	10/100	10.4 lbs	1.02



Coasters

- Perfectly designed to prevent condensation from glasses from ruining tabletops and surfaces
- Ideal for use as a cocktail or coffee coaster at any location where drinks are served
- Various shapes, sizes and materials available

Series	Item	Square	Round	Scalloped	Size	Material	Design	Pack	Weight	Cube
		✓	✓	✓						
Beer Coasters	BC35-NRA		✓		3½"	35 Pt Pulp Board	Printed	5/1000	42 lbs	1.49
	BC35-NRA-SQ	✓			3½"	35 Pt Pulp Board	Printed	5/1000	49 lbs	1.49
	BC45-NRA		✓		3½"	45 Pt Pulp Board	Printed	5/800	42 lbs	1.49
	BC45-NRA-SQ	✓			3½"	45 Pt Pulp Board	Printed	5/800	49 lbs	1.49
	BC35PW		✓		3½"	35 Pt Pulp Board	Plain White	5/1000	49 lbs	1.49
	BC35PW-SQ	✓			3½"	35 Pt Pulp Board	Plain White	5/1000	49 lbs	1.49
	BC45PW-SQ	✓			3½"	45 Pt Pulp Board	Plain White	5/800	49 lbs	1.49
Catch All Coasters	CAC171		✓	✓	3¾"	6 Ply Cellulose, Wax back	Greek Key	10/1000	28 lbs	1.49
	CACPW		✓	✓	3¾"	6 Ply Cellulose, Wax back	Plain White	10/1000	28 lbs	1.49
Royal B Coasters	RBC171		✓	✓	3¾"	Budget Board	Gold Greek Key	4/2500	27 lbs	1.19
	RBCDC		✓	✓	3¾"	Budget Board	Orange Decaf	4/2500	27 lbs	1.19
	RBCPW		✓	✓	3¾"	Budget Board	Plain White	4/2500	27 lbs	1.19



BC45-NRA



CAC171



RBCDC





FRY OIL FILTRATION

Proper filtration is the most effective and economical way to not only extend the life of frying oil, but also improve the quality and taste of fried foods. AmerCareRoyal offers a variety of filter cones and holders for manual cooking oil filtration. We also feature a range of oil filter disposable sheets, envelopes and discs in an array of dimensions and flow rates that fit various manufacturer's fryer brands.

Filter Envelopes	33
Filter Discs.....	34
Filter Cones.....	34
Filter Sheets	34
Miracle Fry Powder.....	35



Fry Oil Filtration



Fry Oil Filter Papers

- Dramatically increase the life of your fryer oil
- Increases economic efficiency as it costs less to filter than to replace oil
- Improves safety by promoting the use of the machines' automatic filtration systems

Filter Envelopes

	Item	Overall Size (W x L)	Edges	Hole	Diameter	Side (edge to hole)		Pack	Weight	Cube
						A	B			
Cellulose Paper	FE1113	11" x 13"	3 sewn, 1 open	2 sides	7/8"	5 ⁹ / ₁₆ "	5 1/2"	1/100	7.7 lbs	0.56
	FE121438P	12" x 14 ³ / ₈ "	3 sewn, 1 open	2 sides	1 1/2"	7 1/4"	6 1/8"	1/100	8.9 lbs	0.56
	FE1221	12" x 21 ¹ / ₂ "	3 sewn, 1 open	2 sides	1 1/32"	10 ⁵ / ₈ "	6"	1/100	12 lbs	0.61
	FE141634	14" x 16"	3 sewn, 1 open	1 side	3/4"	7"	9 1/4"	1/100	7 lbs	0.61
	FE1418	14" x 18"	3 sewn, 1 open	1 side	1 1/2"	6"	6 1/4"	1/100	13.5 lbs	0.96
	FE1422P	14 1/4" x 22"	3 sewn, 1 open	1 side	1 1/2"	9 ⁷ / ₈ "	7 1/8"	1/100	16.5 lbs	1.07
	FE145205	14 1/2" x 20 1/2"	3 sewn, 1 open	1 side	1 1/2"	6 1/2"	7 3/4"	1/100	7 lbs	0.61
	FE1521	15 1/2" x 21"	3 sewn, 1 open	1 side	1 1/2"	7 3/4"	10 1/4"	1/100	7 lbs	0.61
	FE1718	17 1/2" x 18 1/2"	3 sewn, 1 open	1 side	1 1/2"	6 1/2"	8 3/4"	1/100	16.1 lbs	0.88
	FE1820SP	18 1/2" x 20 1/2"	3 sewn, 1 open	1 side	1 3/8"	8 ⁵ / ₈ "	9 1/4"	1/100	18.6 lbs	1.27
	FE2019	20 ³ / ₄ " x 19 ³ / ₄ "	3 sewn, 1 open	2 sides	1 1/2"	9 ³ / ₄ "	10 1/8"	1/100	20.6 lbs	1.34
	FE2425	24" x 25"	3 sewn, 1 open	1 side	1 3/4"	12 ³ / ₈ "	12 ⁵ / ₈ "	1/100	7 lbs	0.61
	F86	13" x 13 ³ / ₈ "	3 sewn, 1 open	n/a	n/a	n/a	n/a	1/100	8.7 lbs	0.57
	FS1	12 1/4" x 14 1/4"	3 sewn, 1 open	2 sides	1 1/2"	6 ⁷ / ₈ "	10 ³ / ₈ "	1/48	4.6 lbs	0.39
HS1415	14" x 15"	3 sewn, 1 open	1 side	7/8"	7"	7 1/8"	1/100	10.8 lbs	0.69	
Non-Woven Rayon	FE1422W	14" X 22 1/4"	3 sewn, 1 open	1 side	1 1/2"	9 ⁷ / ₈ "	7 1/8"	1/100	5.5 lbs	0.71
	HP1320-100	13 ⁵ / ₈ " X 20 1/2"	3 sewn, 1 open	1 side	1 1/2"	6 ¹³ / ₁₆ "	9 1/2"	1/100	4.9 lbs	0.61
	HP918	9 1/4" X 18 1/4"	3 sewn, 1 open	1 side	1 1/2"	4 ⁵ / ₈ "	9 1/2"	1/100	3.6 lbs	0.39

Measure width and length or diameter of the filter to the outermost points.
Note any hole in the filter, the location of the hole and the diameter of the hole.

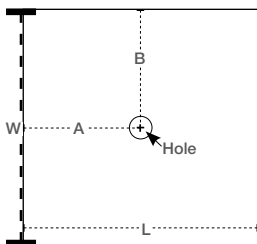

Sheets & Envelopes

1. Measure length and width
2. If a hole is present:
 - i. Measure across the opening of the hole to determine the diameter
 - ii. Sheet: Measure all sides to the outside edge of the hole to determine its position
Envelope: Measure from the closed or stitched points of the filter to the edge of the hole
 - iii. You should have three measurements for the hole position when you've finished
 - iv. If measuring a hole on an envelope, make a note if the hole is through one side or passes through both sides of the filter

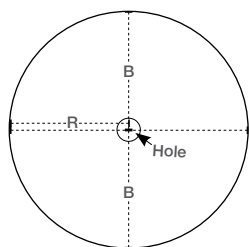

Discs

1. Measure the diameter of the disc
2. If a hole is present:
 - i. Measure across the opening of the hole to determine the diameter
 - ii. Measure all sides to the outside edge of the hole to determine its position

Cones

1. Measure the radius of the cone
 - i. Measure from center to edge to determine the radius of the cone

Filter Discs

	Item	Overall Size (W x L)	Edges	Hole	Diameter	Side (edge to hole)		Pack	Weight	Cube
						A	B			
Cellulose Paper	MF312-100	12" Diameter	unfinished	2 sided oblong	3" x 1/4"	5 3/4"	4 1/2"	1/100	3.0 lbs	0.27
	KDFD14	14" Diameter	unfinished	4 tabs	2 5/8"	n/a	7"	1/100	4.8 lbs	0.24
	FD1575	15 3/4" Diameter	unfinished	n/a	n/a	n/a	9 7/8"	1/100	5.3 lbs	0.33
	FD1778	17 3/4" Diameter	unfinished	n/a	n/a	n/a	n/a	1/100	6.9 lbs	0.42
	FD18-8	18 3/8" Diameter	unfinished	1 side	1 5/8"	n/a	9 3/16"	1/100	6.9 lbs	0.47
	FD215	21 1/2" Diameter	unfinished	n/a	n/a	n/a	10 3/4"	1/100	9.6 lbs	0.65
	FD2178	21 7/8" Diameter	unfinished	1 side	1 5/8"	n/a	9 15/16"	1/100	9.8 lbs	0.21
	FD235	23 1/2" Diameter	unfinished	1 side	1 5/8"	n/a	11 3/4"	1/100	12.0 lbs	1

Filter Cones

Item	Description	Material	Edges	Hole	Diameter	Pack	Weight	Cube
EFC10	Econoline Filter Cones	Cellulose Paper	folded & sewn	n/a	10"	10/50	8.7 lbs	1.15
RFC13	Royal Filter Cones	Cellulose Paper	folded & sewn	n/a	13"	1/100	2.8 lbs	0.32

Filter Sheets

	Item	Overall Size (W x L)	Pack	Weight	Cube
Cellulose Paper	DF16	16 3/8" x 18 3/8"	1/100	7.6 lbs	0.42
	FS111820	11 1/8" x 20"	1/100	7 lbs	1.12
	FS112258	11" x 22 5/8"	1/100	6.5 lbs	0.35
	FS11751175	11 3/4" x 11 3/4"	1/100	3.6 lbs	0.21
	FS1218P	12" x 18"	1/1000	50.9 lbs	2.41
	FS1222	12 5/8" x 22 5/8"	1/100	7.2 lbs	0.54
	FS12235	12" x 23 1/2"	1/100	7 lbs	0.61
	FS1321	13" x 21"	1/100	7.3 lbs	0.56
	FS13524	13 1/2" x 24"	1/100	8.4 lbs	0.45
	FS1430H	14" x 30"	1/100	7 lbs	1.11
	FS147823	14 7/8" x 23 1/8"	1/100	8.8 lbs	0.48
	FS15215	15" x 21 1/2"	1/100	8.2 lbs	0.45
	FS1638	16 3/8" x 24 3/8"	1/100	9.9 lbs	0.49
	FS1728	17 1/2" x 28"	1/100	12.3 lbs	0.68
	FS195275	27 1/2" X 19 1/2"	1/100	7 lbs	0.9
	FS2430	24" x 30"	1/100	18.4 lbs	1.06
Non-Woven Rayon	FS1217-100	12 1/2" x 17 3/4"	1/100	2.3 lbs	0.29
	FS1625	16 1/2" x 25 1/2"	1/100	4.1 lbs	0.42
	FS213325	21" x 33 1/4"	1/100	7 lbs	0.89



Filter Cone Holder

- Holds the filter cone in place to assist in draining oils
- Recommended for use in combination with 10" filters
- 13" filters are easily accommodated
- A must-have for any foodservice location

Item	Description	Pack	Weight	Cube
FCH10-1	10" Filter Cone Holder	1/1	1.5 lbs	0.82



Miracle FRYING OIL POWDER



QSR's BEST KEPT SECRET!
100% Magnesium Silicate

CONSISTENT
COLOR & TASTE

SAVE MONEY

EXTEND LIFE
OF OIL



Miracle Fry Powder

- Made from magnesium silicate
- A proven method to increase the life of cooking oil
- Used in the filtration process to remove carbon particles that can host bacteria that attacks your oil and creates acidity

Item	Pack	Weight	Cube
MFP40	1/1	44.3 lbs	1.55
MFP22	1/22	22.9 lbs	0.69





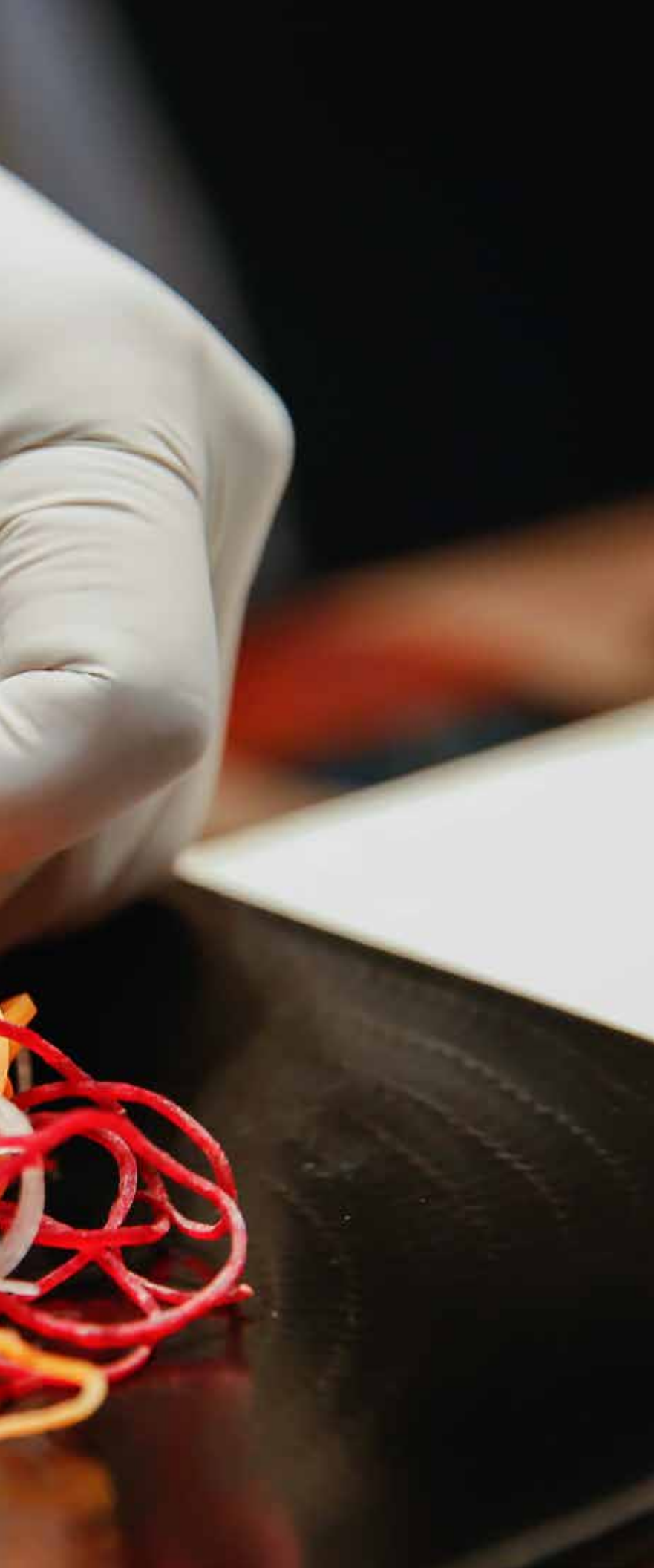

GLOVES

AmerCareRoyal has the disposable glove style, fit and function for every need in the foodservice, janitorial and sanitation industries. Choose from our extensive variety of gloves that have been specifically engineered to protect against spreading foodborne illness, contact with environmental/bio hazards or chemicals and the risk of puncture.

C2 Hybrid Gloves	39
Nitrile Gloves.....	43
Poly Gloves	47
Synthetic Gloves.....	49
Vinyl Gloves.....	51
Latex Gloves	55
Yellow Rubber Gloves	57
Glove Dispensers	57



Gloves



Our serving utensils can be found on **Page 14!**

*C2 Hybrid, Gen 3.0, Diamond Grip
3699 Series*

Back
of house

Janitorial

Safety
and
Industrial

Hybrid Gloves

The C2 series of gloves are the industry's first hybrid, synthetic powder free gloves designed for enhanced fit and flexibility and are 100% recyclable.

- More elasticity than vinyl, resulting in a snug fit
- Patented diamond pattern and tapered cuff provides superior dexterity and grip
- Manufactured in reduced smog facility that recycles excess material
- PVC, phthalate, latex, vinyl, carcinogen and cornstarch allergen free
- FDA approved for foodservice
- 100% recyclable with plastic bag or film recycling
- Meets California Prop 65 regulations, and when not recycled, will take up 50% less landfill space than other gloves due to their thin composition

Application:



Dietary



Foodservice



School

Hybrid Gloves



**C2 Hybrid, Heavy Duty,
Diamond Grip 3899 Series**



The Heavy Duty Hybrid Gloves are 100% latex free and PVC free. They are constructed from 100% recyclable materials and have a diamond sure grip texture for better grip.



**C2 Hybrid, Gen 2.0
3499 Series**



The C2 Generation 2.0 Hybrid Gloves are 100% latex free and PVC free. They are constructed from 100% recyclable materials and have an embossed finish.



**C2 Hybrid, Gen 3.0,
Diamond Grip 3699 Series**



The C2 Generation 3.0 are 100% latex free and PVC free. They are constructed from 100% recyclable materials and have a diamond sure grip texture for better grip.



**C2 Hybrid, Gen 3.0 Heavy Duty,
Synthetic 3799 Series**



The Heavy Duty Hybrid Gloves are 100% latex free and PVC free. They are constructed from 100% recyclable materials and have a diamond sure grip texture for better grip.



**C2 Hybrid, Gen 3.0, Synthetic
3599 Series**



The C2 Generation 3.0 Hybrid Gloves are 100% latex free and PVC free. They are constructed from 100% recyclable materials and have a diamond sure grip texture for better grip.



**C2 Hybrid, Gen 1.0
3299 Series**



The C2 Generation 1.0 Hybrid Gloves are 100% latex free and PVC free. They are constructed from 100% recyclable materials and have an embossed finish.



Gloves



As the industry's first and only hybrid glove with Sure Grip technology and patented tapered cuffs, this glove is unlike any other.

THINK GREEN & Save Money

Through its clean manufacturing, our C2 glove reduces Earth harming smog. Even if not recycled, it takes up half the landfill space.

- ◆ Cost savings can exceed 20% when compared to vinyl
- ◆ PVC, phthalate, latex, carcinogen and cornstarch allergen free
- ◆ Meets California Prop 65 regulations
- ◆ 100% Recyclable
- ◆ FDA approved

62%



Less Material Waste

(measured in pounds)

54%



Lower Distribution Costs

90%



Lower Harmful Emissions

54%



Less Storage Space

NOTE: Chart information compared to PVC. Chart data based on comparing 2.0 gram C2 Hybrid gloves and 5 gram PVC gloves.































CORRECT SIZING IS KEY

When wearing C2 Hybrid gloves, a snug fit works best. **One size smaller than your usual glove size.** With 300% more stretch than vinyl, it conforms to your hand providing superior dexterity and grip.

- 1 Pull the glove half way onto your hand from the cuff area near your palm
- 2 Interlock once to get the best fit
- 3 As the cuff is pulled, the glove will mold to the wrist



Hybrid Gloves

Series	Item	Color	Size	Powder Free	Texture	Pack	Weight	Cube
C2 Hybrid, Heavy Duty, Diamond Grip	38991		S	✓	✓	5/200	7.3 lbs	0.34
	38992		M	✓	✓	5/200	7.9 lbs	0.32
	38993		L	✓	✓	5/200	8.8 lbs	0.32
	38994		XL	✓	✓	5/200	9.9 lbs	0.34
	38995		XXL	✓	✓	5/180	9.9 lbs	0.36
C2 Hybrid, Gen 2.0	34990		XS	✓		5/200	5.3 lbs	0.34
	34991		S	✓		5/200	5.3 lbs	0.34
	34992		M	✓		5/200	5.5 lbs	0.33
	34993		L	✓		5/200	5.7 lbs	0.35
	34994		XL	✓		5/200	6.2 lbs	0.35
	34995		XXL	✓		5/180	6.2 lbs	0.35
C2 Hybrid, Gen 3.0, Diamond Grip	36991		S	✓	✓	5/200	5.5 lbs	0.34
	36992		M	✓	✓	5/200	5.7 lbs	0.34
	36993		L	✓	✓	5/200	6.2 lbs	0.35
	36994		XL	✓	✓	5/200	6.5 lbs	0.34
	36995		XXL	✓	✓	5/180	6.5 lbs	0.34
C2 Hybrid, Gen 3.0 Heavy Duty, Synthetic	37991		S	✓	✓	5/200	5.7 lbs	0.34
	37992		M	✓	✓	5/200	5.7 lbs	0.34
	37993		L	✓	✓	5/200	5.7 lbs	0.34
	37994		XL	✓	✓	5/200	5.7 lbs	0.34
	37995		XXL	✓	✓	5/180	5.7 lbs	0.34
C2 Hybrid, Gen 3.0, Synthetic	35991		S	✓	✓	5/200	5.1 lbs	0.34
	35992		M	✓	✓	5/200	5.3 lbs	0.34
	35993		L	✓	✓	5/200	5.7 lbs	0.34
	35994		XL	✓	✓	5/200	6.2 lbs	0.34
	35995		XXL	✓	✓	5/180	6.2 lbs	0.34
C2 Hybrid, Gen 1.0	32991		S	✓		5/200	5.1 lbs	0.34
	32992		M	✓		5/200	4.9 lbs	0.32
	32993		L	✓		5/200	5.1 lbs	0.36
	32994		XL	✓		5/200	6.2 lbs	0.32
	32995		XXL	✓		5/200	6.2 lbs	0.34

Icon Key:





Gloves



Don't forget your lemon wraps - Page 149!

Edge, White
5099 Series

Nitrile Gloves

Made of synthetic latex, AmerCareRoyal's disposable nitrile gloves provide a high level of dexterity, flexibility and comfort for extended use.

- Offer excellent puncture and tear resistance
- A top barrier protection against common cleaning chemicals
- Ideal for fast food operations and institutional use
- Provide superior resistance to citrus oils and fatty meats

Application:



Ambulance



Automotive



Beauty Supply



Chemotherapy Approved



Dentist



Doctors Office



ERs



Foodservice



High Risk
Medical Environments



Hospital



Laboratory



Painting



Tattoo



Manage Waste

Nitrile Gloves



Atlantic
1099 Series



Perfect for general cleaning and maintenance, these gloves will protect hands from some mild irritants.



Black Rhino
6099 Series



These Rhino Nitrile Gloves are resistant to oils, corrosive chemicals and punctures. They are powder and latex free. A suitable option for people with latex allergies or sensitivities. These gloves feature a textured design and help to provide a confident grip.



Blue Rhino
4099 Series



These Rhino Nitrile Gloves are resistant to oils, corrosive chemicals and punctures. They are powder and latex free. A suitable option for people with latex allergies or sensitivities. These gloves feature a textured design and help to provide a confident grip.



Edge, Black
8299 Series



Edge Black Nitrile Gloves feature a textured design and are powder free and latex free, making them a suitable option for people with latex allergies or sensitivities.



Edge, White
5099 Series



These lightweight Edge Nitrile Gloves are powder and latex free, making them a suitable option for people with latex allergies or sensitivities. These gloves feature a textured design and help to provide a confident grip.



Black Widow™
1400 Series



Black Widow™ Nitrile Gloves are strong, exam grade and powder free gloves that are a good option for tattoo artists and healthcare professionals. They are 100% latex free and optimal for people with latex allergies or sensitivities. Black Widow Nitrile Gloves' textured construction provide a confident grip when holding medical instruments and black color gives discrete visibility of blood and ink.



Gloves



Grape Grip™
600 Series



AmerCareRoyal's Grape Grip PF Nitrile Exam Gloves are perfect for all-around use by healthcare professionals and are approved for use for medical exams. Additionally, these gloves offer barrier protection against the synthetic drug Fentanyl and a range of chemotherapy drugs. Grape Grip PF Nitrile Exam Gloves are 100% latex free and a good choice for people with latex allergies or sensitivities.



Med-Edge™
650 Series



AmerCareRoyal's Med-Edge Nitrile Gloves feature an exam grade, powder free design. They are 100% latex free and are suitable for people with latex allergies or sensitivities. Perfect for doctors, dentists and healthcare workers, AmerCareRoyal's Med-Edge Nitrile Gloves are textured and offer a confident grip when holding medical instruments.



Nitra-Flex™
700 Series



AmerCareRoyal's Nitra-Flex Nitrile Gloves are an exam grade, powder free and 100% latex free and are suitable for people with latex allergies and sensitivities. These thin chemical resistant gloves are textured for a confident grip when holding medical instruments and are a good choice for hospitals, dentists and other healthcare professionals.



Protector XR™
900 Series



Protector XR Nitrile Gloves have an exam grade, powder free design and are an optimal choice for first responders, ambulances, emergency rooms and other high-risk medical environments. Our durable gloves are 100% latex free, suitable for people with latex allergies or sensitivities. With a 12-inch long beaded cuff that adds additional protection and strength.



Pacific
2099 Series



These Pacific Nitrile Gloves are chemical resistant. They are powder and latex free, and suitable for people with latex allergies or sensitivities.

Nitrile Gloves

Series	Item	Color	Size	Powder Free Texture	Pack	Weight	Cube
Atlantic	10991		S		10/100	11.0 lbs	0.69
	10992		M		10/100	11.5 lbs	0.68
	10993		L		10/100	12.6 lbs	0.68
	10994		XL		10/100	13.2 lbs	0.63
Black Rhino	60991		S	✓ ✓	10/100	14.1 lbs	0.76
	60992		M	✓ ✓	10/100	15.6 lbs	0.83
	60993		L	✓ ✓	10/100	17.2 lbs	0.81
	60994		XL	✓ ✓	10/100	18.9 lbs	0.77
	60995		XXL	✓ ✓	10/100	18.6 lbs	0.73
Blue Rhino	40991		S	✓ ✓	10/100	14.3 lbs	0.82
	40992		M	✓ ✓	10/100	15.7 lbs	0.84
	40993		L	✓ ✓	10/100	15.0 lbs	0.82
	40994		XL	✓ ✓	10/100	17.9 lbs	0.82
	40995		XXL	✓ ✓	10/90	16.7 lbs	0.80
Edge, Black	82991		S	✓ ✓	10/100	6.0 lbs	0.57
	82992		M	✓ ✓	10/100	6.6 lbs	0.57
	82993		L	✓ ✓	10/100	7.3 lbs	0.57
	82994		XL	✓ ✓	10/100	7.9 lbs	0.57
Edge, White	50991		S	✓ ✓	10/200	13.2 lbs	0.74
	50992		M	✓ ✓	10/200	14.6 lbs	0.74
	50993		L	✓ ✓	10/200	15.9 lbs	0.74
	50994		XL	✓ ✓	10/200	17.2 lbs	0.74
	50995		XXL	✓ ✓	10/180	18.5 lbs	0.74
Black Widow™ +	14000		XS	✓ ✓	10/100	11.2 lbs	0.79
	14001		S	✓ ✓	10/100	12.8 lbs	0.80
	14002		M	✓ ✓	10/100	13.8 lbs	0.80
	14003		L	✓ ✓	10/100	14.3 lbs	0.82
	14004		XL	✓ ✓	10/100	15.0 lbs	0.78
	14005		XXL	✓ ✓	10/100	14.9 lbs	0.81

Series	Item	Color	Size	Powder Free Texture	Pack	Weight	Cube
Grape Grip™ +	6000		XS	✓	10/100	8.9 lbs	0.72
	6001		S	✓	10/100	9.2 lbs	0.69
	6002		M	✓	10/100	10.4 lbs	0.75
	6003		L	✓	10/100	10.7 lbs	0.64
	6004		XL	✓	10/100	11.1 lbs	0.72
Med-Edge™ +	6501		S	✓ ✓	10/200	14.6 lbs	0.78
	6502		M	✓ ✓	10/200	15.7 lbs	0.80
	6503		L	✓ ✓	10/200	17.2 lbs	0.81
	6504		XL	✓ ✓	10/200	18.5 lbs	0.80
Nitra-Flex™ +	7000		XS	✓ ✓	10/100	8.1 lbs	0.63
	7001		S	✓ ✓	10/100	9.8 lbs	0.64
	7002		M	✓ ✓	10/100	11.0 lbs	0.63
	7003		L	✓ ✓	10/100	11.9 lbs	0.65
	7004		XL	✓ ✓	10/100	11.9 lbs	0.64
Protector XR™ +	9001		S	✓	10/50	14.1 lbs	0.79
	9002		M	✓	10/50	12.6 lbs	0.79
	9003		L	✓	10/50	15.4 lbs	0.75
	9004		XL	✓	10/50	14.2 lbs	0.75
	9005		XXL	✓	10/50	14.4 lbs	0.78
Pacific	20991		S	✓ ✓	10/100	9.9 lbs	0.65
	20992		M	✓ ✓	10/100	10.8 lbs	0.65
	20993		L	✓ ✓	10/100	12.6 lbs	0.67
	20994		XL	✓ ✓	10/100	12.7 lbs	0.67
	20995		XXL	✓ ✓	10/100	11.5 lbs	0.64

Icon Key:

Chemo Approved
 Exam Grade
 Fentanyl Protection
 Food Safe
 Latex Free
 Lightly Powdered
 Powder Free
 Textured



Gloves



*Foodguard
399 Series*

Poly Gloves

AmerCareRoyal disposable polyethylene gloves offer the best low-cost option for light tasks that require frequent glove changes.

- Low-density material provides excellent wet barrier protection
- Complies with Good Manufacturing Practices (GMP) and FDA standards for safe food handling

Application:



Dietary



Foodservice



School

Poly Gloves



PolyCast
2699 Series



PolyCast Gloves are poly embossed and textured. They are also approved for food use.



Foodguard
399 Series



PolyCast Gloves are poly embossed and approved for food use.



Revolution
499 Series



Not only are these poly embossed, they are made from an advanced PVC formulation and approved for food use.



Foodguard XP
1499 Series



Foodguard XP Poly Gloves are poly embossed and approved for food use.

Series	Item	Color	Size	Powder Free	Texture	Pack	Weight	Cube
PolyCast	26991	☉	S	✓	✓	10/100	4.7 lbs	0.48
	26992	☉	M	✓	✓	10/100	4.8 lbs	0.46
	26993	☉	L	✓	✓	10/100	5.3 lbs	0.48
	26994	☉	XL	✓	✓	10/100	5.3 lbs	0.49
Foodguard	3991	☉	S	✓		10/1000	15.3 lbs	0.71
	3992	☉	M	✓		10/1000	17.2 lbs	0.81
	3993	☉	L	✓		10/1000	25.0 lbs	1.02
	3994	☉	XL	✓		10/1000	17.2 lbs	0.72
Revolution	4991	●	S	✓	✓	10/100	5.1 lbs	0.60
	4992	●	M	✓	✓	10/100	5.4 lbs	0.60
	4993	●	L	✓	✓	10/100	6.2 lbs	0.60
	4994	●	XL	✓	✓	10/100	6.1 lbs	0.59
Foodguard XP	14991	☉	S	✓		4/500	4.5 lbs	0.37
	14992	☉	M	✓		4/500	4.6 lbs	0.38
	14993	☉	L	✓		4/500	5.2 lbs	0.33
	14994	☉	XL	✓		4/500	4.9 lbs	0.32

Icon Key:





Gloves



Chameleon™
1200 Series

Synthetic Gloves

AmerCareRoyal disposable Synthetic Gloves are an affordable alternative to latex gloves. They have the same look and feel as latex gloves and provide a snug fit with a loose beaded cuff.

- Made of a PVC blend - polyvinyl chloride - petroleum-based material
- Have more stretch than vinyl
- Perfect for delicate tasks requiring flexibility and fingertip sensitivity
- Contains ZERO latex proteins
- Ideal for those who are latex-sensitive and work in fast food operations and institutions
- Use for prep work, slicing, grill line, cake decorating, dough handling, garnishing, and prep
- Available in both powder free or powdered
- Contains USP absorbable dusting powder for optimal tactile sensitivity

Application:



Ambulance



Doctor's Office



ERs



High Risk
Medical Environments

Synthetic Gloves



Gladiator - PF
3199 Series



Gladiator Stretch Vinyl Gloves come lightly powdered or powder free. They are made from advanced PVC formulation and suitable for people with latex allergies.



Gladiator
2199 Series



Gladiator Stretch Vinyl Gloves come lightly powdered or powder free. They are made from advanced PVC formulation and suitable for people with latex allergies.



Chameleon™
1200 Series



Designed to be a latex glove alternative, Chameleon PF Stretch Synthetic Exam Gloves are exam grade, powder and 100% latex free. Chameleon PF Stretch Synthetic Exam Gloves are a great choice for those looking for heightened sensitivity and a good stretchy fit but have latex allergies or sensitivities.

Series	Item	Color	Size	Powder Free	Pack	Weight	Cube
Gladiator - PF	31991	○	S	✓	10/100	12.0 lbs	0.76
	31992	○	M	✓	10/100	13.0 lbs	0.72
	31993	○	L	✓	10/100	14.0 lbs	0.73
	31994	○	XL	✓	10/100	15.0 lbs	0.74
Gladiator	21991	○	S		10/100	12.0 lbs	0.72
	21992	○	M		10/100	13.0 lbs	0.69
	21993	○	L		10/100	14.0 lbs	0.69
	21994	○	XL		10/100	15.0 lbs	0.64
Chameleon™ +	12001	○	S	✓	10/100	12.6 lbs	0.73
	12002	○	M	✓	10/100	14.0 lbs	0.73
	12003	○	L	✓	10/100	15.3 lbs	0.65
	12004	○	XL	✓	10/100	17.1 lbs	0.73

Icon Key:



Exam Grade



Food Safe



Latex Free



Lightly Powdered



Powder Free



Gloves



Anchor PF
2299 Series

Vinyl Gloves

More durable than poly, vinyl gloves are closer fitting for medium duty tasks requiring good sensitivity. Latex free, ambidextrous and flexible, their beaded cuffs provide maximum strength and durability and offer excellent wet and dry barrier protection.

- Can be used near a heat source
- Protect hands in light cleaning situations
- Made of PVC – polyvinyl chloride – a petroleum-based material
- Available in both powder free and powdered with a sterilized cornstarch for ease of donning and absorbing moisture during wear
- Powder free vinyl available for operators who want a cleaner work area and for workers whose hands dry out from extended use
- Use for handling sliced cheese and meats, prep for fresh squeezed juice, pies, pizzas, salads, tacos, burritos and more

Application:



Vinyl Gloves



Sensi-Flex™
500 Series



Sensi-Flex PF Vinyl Exam Gloves are made with an advanced PVC formation that gives our lightweight, medical grade vinyl gloves a slimmer profile. Sensi-Flex PF Vinyl Exam Gloves are 100% powder and latex free and a great option for nursing homes, care facilities and general medical use.



Med-Edge™
550 Series



Med-Edge PF Vinyl Exam Gloves are made with an advanced PVC formation that gives our lightest weight medical grade gloves a super slim profile. Med-Edge PF Vinyl Exam Gloves are 100% powder and latex free.



Anchor
1299 Series



Anchor Vinyl Gloves come with the option of lightly powdered or powder free. They are made from advanced PVC formulation and suitable for people with latex allergies.



Anchor PF
2299 Series



Anchor Vinyl Gloves come with the option of lightly powdered or powder free. They are made from advanced PVC formulation and suitable for people with latex allergies.



Edge
1399 Series



Edge Vinyl Gloves come with the option of lightly powdered or powder free. They are made from advanced PVC formulation and suitable for people with latex allergies.



Edge PF
2399 Series



Edge Vinyl Gloves come with the option of lightly powdered or powder free. They are made from advanced PVC formulation and suitable for people with latex allergies.

Icon Key:



Exam Grade



Food Safe



Latex Free



Lightly Powdered



Powder Free



Gloves



Paradigm
899 Series



Paradigm Vinyl Gloves are powder free. These gloves are made from advanced PVC formulation and 100% latex free.



Sentinel
799 Series



Sentinel Vinyl Gloves are lightly powdered. These gloves are made from advanced PVC formulation and 100% latex free.



Bandit
2899 Series



Bandit Black Vinyl Gloves are powder free. These gloves are made from advanced PVC formulation and 100% latex free.



Odyssey
1199 Series



Odyssey Blue Vinyl Gloves come with the option of lightly powdered or powder free. They are made from advanced PVC formulation and suitable for people with latex allergies.



Odyssey PF
1899 Series



Odyssey Blue Vinyl Gloves come with the option of lightly powdered or powder free. They are made from advanced PVC formulation and suitable for people with latex allergies.

Vinyl Gloves



Series	Item	Color	Size	Powder Free	Pack	Weight	Cube
Sensi-Flex™ +	5001	☼	S	✓	10/100	12.0 lbs	0.75
	5002	☼	M	✓	10/100	13.7 lbs	0.71
	5003	☼	L	✓	10/100	14.8 lbs	0.73
	5004	☼	XL	✓	10/100	15.6 lbs	0.71
Med-Edge™ +	5501	☼	S	✓	10/100	12.1 lbs	0.75
	5502	☼	M	✓	10/100	13.0 lbs	0.69
	5503	☼	L	✓	10/100	14.4 lbs	0.74
	5504	☼	XL	✓	10/100	15.2 lbs	0.71
Anchor	12991	☼	S		10/100	10.0 lbs	0.62
	12992	☼	M		10/100	11.0 lbs	0.64
	12993	☼	L		10/100	12.0 lbs	0.60
	12994	☼	XL		10/100	13.0 lbs	0.62
Anchor PF	22991	☼	S	✓	10/100	10.0 lbs	0.65
	22992	☼	M	✓	10/100	11.0 lbs	0.65
	22993	☼	L	✓	10/100	12.0 lbs	0.61
	22994	☼	XL	✓	10/100	13.0 lbs	0.65
	22995	☼	XXL	✓	10/100	14.0 lbs	0.65
Edge	13991	☼	S		10/100	10.0 lbs	0.62
	13992	☼	M		10/100	11.0 lbs	0.65
	13993	☼	L		10/100	12.0 lbs	0.63
	13994	☼	XL		10/100	13.0 lbs	0.65
Edge PF	23991	☼	S	✓	10/100	11.2 lbs	0.63
	23992	☼	M	✓	10/100	10.8 lbs	0.63
	23993	☼	L	✓	10/100	11.5 lbs	0.63
	23994	☼	XL	✓	10/100	12.5 lbs	0.63

Series	Item	Color	Size	Powder Free	Pack	Weight	Cube
Paradigm	8991	☼	S	✓	10/100	12.2 lbs	0.72
	8992	☼	M	✓	10/100	13.1 lbs	0.70
	8993	☼	L	✓	10/100	14.6 lbs	0.70
	8994	☼	XL	✓	10/100	15.1 lbs	0.70
Sentinel	7991	☼	S		10/100	12.1 lbs	0.72
	7992	☼	M		10/100	13.3 lbs	0.69
	7993	☼	L		10/100	14.8 lbs	0.72
	7994	☼	XL		10/100	15.2 lbs	0.74
Bandit	28991	●	S	✓	10/100	11.5 lbs	0.76
	28992	●	M	✓	10/100	12.1 lbs	0.76
	28993	●	L	✓	10/100	13.2 lbs	0.76
	28994	●	XL	✓	10/100	14.3 lbs	0.76
Odyssey	11991	●	S		10/100	9.9 lbs	0.66
	11992	●	M		10/100	11.0 lbs	0.74
	11993	●	L		10/100	11.7 lbs	0.67
	11994	●	XL		10/100	13.4 lbs	0.71
Odyssey PF	18991	●	S	✓	10/100	12.6 lbs	0.74
	18992	●	M	✓	10/100	10.9 lbs	0.73
	18993	●	L	✓	10/100	12.0 lbs	0.73
	18994	●	XL	✓	10/100	12.2 lbs	0.73
	18995	●	XXL	✓	10/90	13.2 lbs	0.73



Gloves



Ultra-Flex™
300 Series

Latex Gloves

Ultra form-fitting, natural rubber (latex) gloves are made from renewable rubber trees. Latex gloves are a great choice for tasks requiring flexibility and fingertip sensitivity.

- Feature a beaded cuff for maximum strength and durability
- Resists puncturing for reliable barrier protection against contamination
- Great fast food operations, food prepping, medical and institutional use
- Available in both powder free or pre-powdered with USP absorbable dusting powder
- Approved for use in USDA inspected food establishments



Edge PF
2799 Series



Edge Latex Gloves are available in powder free or lightly powdered. These gloves are made with low protein and allergens, and are suitable for sensitive skin. However, not suitable for people with latex allergies. They also feature a textured grip for confident handling of tools and instruments.



Edge
1799 Series



Edge Latex Gloves are available in powder free or lightly powdered. These gloves are made with low protein and allergens, and are suitable for sensitive skin. However, not suitable for people with latex allergies. They also feature a textured grip for confident handling of tools and instruments.



Tuff-Skin
999 Series



Tuff-Skin Gloves are made with low protein and allergens, and are suitable for sensitive skin. Not suitable for people with latex allergies.

Application:



Ambulance



Automotive



Beauty Supply



ERS



High Risk
Medical Environments



Hospital



Janitorial



School

Latex Gloves



Apollo
699 Series



Apollo Latex Gloves are made with low protein and allergens, and are suitable for sensitive skin. Not suitable for people with latex allergies.



Ultra-Flex™
300 Series



Ultra Flex Powder Free Latex Exam Gloves are powder free, medical grade and a good choice for all-around healthcare use. Featuring a low protein and allergen composition, Ultra Flex PF gloves are textured for confident gripping.



Response ER™ High Risk
800 Series



Response ER Gloves are a solid choice for high risk medical environments like ambulances, emergency rooms and much more. These tough, medical grade, powder free gloves feature a low protein and allergen composition and are more than twice the thickness of ordinary latex gloves. They have an extended 12" long beaded cuff.



Ninja™
200 Series



Ninja Black PF Latex Exam Gloves are optimal for general medical environments or for tattoo artists. Our gloves are medical grade, powder free and feature a low protein and allergen composition. Ninja Black PF Latex Gloves are textured for confident gripping.

Series	Item	Color	Size	Powder Free	Texture	Pack	Weight	Cube
Edge PF	27991	○	S	✓	✓	10/100	11.5 lbs	0.68
	27992	○	M	✓	✓	10/100	12.5 lbs	0.65
	27993	○	L	✓	✓	10/100	13.5 lbs	0.65
	27994	○	XL	✓	✓	10/100	14.7 lbs	0.65
Edge	17991	○	S		✓	10/100	10.9 lbs	0.65
	17992	○	M		✓	10/100	11.7 lbs	0.68
	17993	○	L		✓	10/100	13.0 lbs	0.63
	17994	○	XL		✓	10/100	13.9 lbs	0.66
Tuff-Skin	9991	○	S			10/100	11.6 lbs	0.59
	9992	○	M			10/100	13.3 lbs	0.66
	9993	○	L			10/100	13.8 lbs	0.65
	9994	○	XL			10/100	14.7 lbs	0.60
Apollo	6991	○	S	✓		10/100	12.1 lbs	0.58
	6992	○	M	✓		10/100	13.5 lbs	0.56
	6993	○	L	✓		10/100	14.5 lbs	0.63
	6994	○	XL	✓		10/100	14.9 lbs	0.64

Series	Item	Color	Size	Powder Free	Texture	Pack	Weight	Cube
Ultra-Flex™ +	3000	○	XS	✓	✓	10/100	14.3 lbs	0.81
	3001	○	S	✓	✓	10/100	15.7 lbs	0.83
	3002	○	M	✓	✓	10/100	17.3 lbs	0.83
	3003	○	L	✓	✓	10/100	18.5 lbs	0.86
Response ER™ High Risk +	3004	○	XL	✓	✓	10/100	19.4 lbs	0.81
	8001	●	S	✓	✓	10/50	22.3 lbs	1.10
	8002	●	M	✓	✓	10/50	23.5 lbs	1.14
	8003	●	L	✓	✓	10/50	24.4 lbs	1.12
Ninja™ +	8004	●	XL	✓	✓	10/50	26.8 lbs	0.96
	2001	●	S	✓	✓	10/100	14.5 lbs	0.76
	2002	●	M	✓	✓	10/100	15.9 lbs	0.83
	2003	●	L	✓	✓	10/100	17.4 lbs	0.76
	2004	●	XL	✓	✓	10/100	18.1 lbs	0.80

Icon Key:





Gloves

Our gloves and scouring pads go hand in hand! See them on Page 107!



Neptune 599 Series

Yellow Rubber Gloves

Tough, all purpose, reusable gloves used for food processing, cleaning and janitorial duties. From dishwashing to cleaning restrooms, these yellow flock lined gloves offer reliable coverage.

- Made from natural rubber (latex) from renewable rubber trees
- Chlorinated and powder free to minimize particulate contamination
- Flock lined for moisture absorption
- Embossed finger tips provide a better grip and generous 18 mm thickness delivers excellent resistance to chemicals and detergents
- Recommend elbow length poly gloves be worn underneath to further protect workers



Neptune 599 Series



These are a perfect household glove. Each pair of gloves comes individually wrapped, which helps to avoid contamination. These gloves are flock lined with beaded cuffs and are easy to put on and remove.

Series	Item	Color	Size	Powder Free	Texture	Pack	Weight	Cube
Neptune	5991	Yellow	S	✓	✓	10/12	12.9 lbs	0.94
	5992	Yellow	M	✓	✓	10/12	13.8 lbs	0.97
	5993	Yellow	L	✓	✓	10/12	15.1 lbs	0.99
	5994	Yellow	XL	✓	✓	10/12	16.0 lbs	0.98

Application:



Glove Dispensers

- Dispense gloves at ease
- Designed with a sturdy wire frame
- Easy to use and install
- Hardware included

Item	Color	Pack	Weight	Cube
RWGD1	White	1/1	1.0 lbs	0.14
99001	White	5/2	9.4 lbs	0.81



Glove Size Indicator Chart

We Have A Glove For That

AmerCareRoyal's disposable gloves can be used in a variety of jansan, foodservice or medical applications. They provide added protection to users and help maintain sterile environments. Whether needing hybrid, latex, nitrile, poly, synthetic or vinyl, we have a range of sizes available in colorful, easy to read packaging.

Simply place the widest portion of your hand over the size indicator chart to find the glove size that is ideal for you.

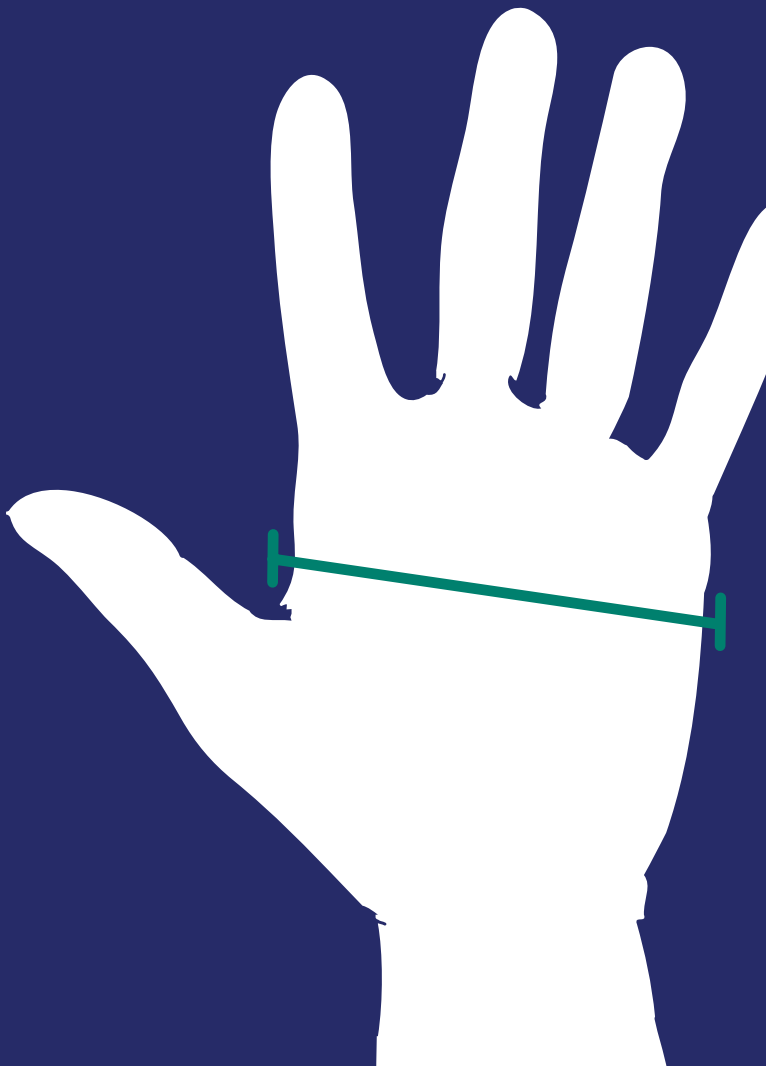

If the designated portion of your hand is smaller than 78mm a size extra small may be ideal for you

If the designated portion of your hand is larger than 110mm a size extra-extra large may be ideal for you

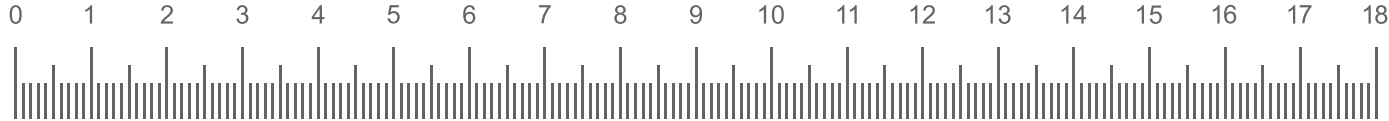

GUEST CARD

Date

Table

Guests

Server

W4

2

3

APPT-SOUP/SAL-ENTREE-VEG/POT

Egy Ho-

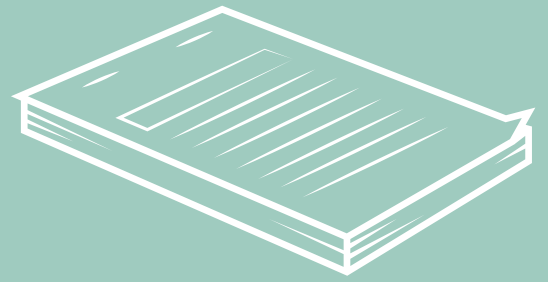

GUEST CHECKS & REGISTER ROLLS

Register Rolls provide a paper record of transactions at ATMs, POS printers and cash registers, hotels and restaurants, grocery stores and retailers. AmerCareRoyal offers quality receipt tape in 3 major styles: Bond, Carbonless and Thermal.

AmerCareRoyal's guest checks offer simplicity, speed, accuracy and professionalism for everywhere from diners to upscale restaurants alike. Guest checks help streamline point of sale, increase profits, avoid mistakes, reduce waste, and improve table service for a seamless dining experience. Choose from several options and designs - printed, unlined or lined with easy tear dispensing cartons and bar codes.

Guest Checks.....	61
Ink Ribbons	64
Register Rolls	68

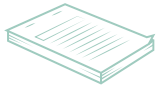

Guest Checks & Register Rolls



GC4797-3B

Guest Checks

AmerCareRoyal's guest checks offer simplicity, speed, accuracy and professionalism for everywhere from diners to upscale restaurants. Choose from several options and designs - printed, unlined or lined with easy tear dispensing cartons and bar codes.

Whether you need classic waiter pads or customized options, AmerCareRoyal's selection of economical single-part paper, heavyweight board, multi-part carbon or carbonless guest checks help streamline point of sale, increase profits, avoid mistakes, reduce waste and improve table service for a seamless dining experience.



Guest Checks & Register Rolls



GC1200-1



GC3516-1



GC3616-1



GC3616WP-1



GCKDUP-1



GC3632-1



GC3674-1



GC4774-1B



GC4932-1

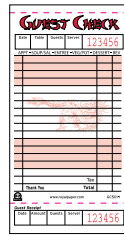

GC501-1

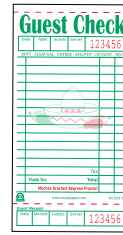

GC503-1

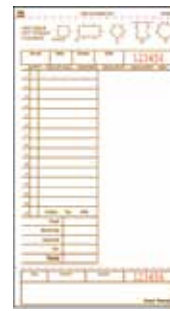

GC6932-1



GCP3632-1

Single Part Guest Checks

- Allow your service team to take accurate orders from front of house to back of house
- Choose from multiple color, line count, paper or board and other styles

Paper

- Single Part Paper guest checks are an economical, lightweight paper offered in booked style and a variety of sizes, colors and print designs
- Sturdy board for convenience

Board

- Single Part Board guest checks come in board stock paper for stability and durability
- Stapled on top with a perforated receipt, they are offered in various sizes and colors

Item	Color	Lines	Paper	Board	Booked	Loose	Size	Checks/Pack	Items/Pack	Pack	Weight	Cube
GC1200-1	○	15	✓		✓		3½" x 6¾"	100	100	10/10	22.1 lbs	0.53
GC3516-1	○	14	✓		✓		3½" x 5½"	100	100	10/10	17.2 lbs	0.42
GC3616-1	○	16	✓		✓		3½" x 6¾"	50	100	5/10	11.1 lbs	0.28
GC3616WP-1	○	8	✓		✓		3½" x 6¾"	50	100	5/10	11.1 lbs	0.28
GCKDUP-1	○	0	✓		✓		3½" x 6"	50	100	10/10	11.1 lbs	0.26
GC3632-1	○	15		✓	✓		3½" x 6¾"	50	50	5/10	12.2 lbs	0.30
GC3674-1	○	16		✓	✓		3½" x 6¾"	50	50	5/10	13.5 lbs	0.33
GC4774-1B	○	13		✓	✓		4¼" x 7¼"	50	50	5/10	15.6 lbs	0.42
GC4932-1	○	15		✓		✓	4¼" x 9"	250 Loose Checks		8/250	16.4 lbs	0.39
GC501-1	○	18		✓	✓		3½" x 6¾"	50	50	5/10	12.5 lbs	0.30
GC503-1	○	15		✓	✓		3½" x 6¾"	50	50	5/10	12.5 lbs	0.30
GC6932-1	○	15		✓		✓	5" x 9"	250 Loose Checks		8/250	19.0 lbs	0.44
GCP3632-1	○	15		✓	✓		3½" x 6¾"	50	50	5/10	14.7 lbs	0.39

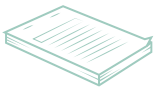

Guest Checks & Register Rolls

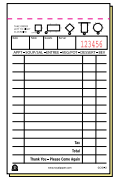

GC101-2



GC1A-2



GC11A-3



GC4700WP-2



GC4797-2
GC4797-2B



GC4797-3B



GC4900-2
GC4900-2B



GC12A-2



GC6000-2



GC4997-2
GC4997-2B



GC4997-3



GC7000-2



GCT4797-2
GCT4797-2B

Multi-Part Guest Checks

Carbon

- Available in multiple colors and line configurations
- Great way ensure accuracy from the front of house to the back of house

Carbonless

- Multi-copy carbonless guest checks are available in multiple colors and line configurations
- Great way to take accurate orders in food establishments

Item	Color	Parts	Lines	Paper	Board	Booked	Loose	Carbon	Size	Checks/Item	Items/Pack	Pack	Weight	Cube
GC101-2	○	2	13	✓	✓				3½"x5½"	50	100	10/10	19.4 lbs	0.41
GC1A-2	○	2	13	✓	✓				3½"x5½"	50	100	10/10	19.4 lbs	0.41
GC11A-3	○	3	14	✓	✓				3½"x6½"	50	50	5/10	14.6 lbs	0.34
GC4700WP-2	○	2	8	✓	✓				4¼"x8¼"	50	40	4/10	11.7 lbs	0.32
GC4797-2	○	2	13		✓		✓		4¼"x7¼"	250 Loose Checks		8/250	16.8 lbs	0.45
GC4797-2B	○	2	13		✓	✓			4¼"x7¾"	50	40	4/10	18.8 lbs	0.41
GC4797-3B	○	3	13		✓	✓			4¼"x7¾"	50	40	8/5	26.5 lbs	0.54
GC4900-2	○	2	16		✓		✓		4¼"x8¼"	250 Loose Checks		10/250	22.4 lbs	0.52
GC4900-2B	○	2	16		✓	✓			4¼"x8¼"	50	50	5/10	26.6 lbs	0.60
GC4997-2	○	2	15		✓		✓		4¼"x8½"	250 Loose Checks		8/250	16.9 lbs	0.51
GC4997-2B	○	2	15		✓	✓			4¼"x8½"	50	40	4/10	21.1 lbs	0.51
GC4997-3	○	3	15		✓		✓		4¼"x8½"	250 Loose Checks		8/250	23.0 lbs	0.61
GC7000-2	○	2	17		✓	✓			3½"x6¾"	50	50	5/10	10.6 lbs	0.26
GCT4797-2	○	2	12		✓		✓		4¼"x7¾"	250 Loose Checks		8/250	18.7 lbs	0.46
GCT4797-2B	○	2	12		✓	✓			4¼"x7¾"	50	40	4/10	19.5 lbs	0.43
GC12A-2	○	2	12	✓		✓		✓	3½"x5½"	50	100	10/10	19.4 lbs	0.50
GC6000-2	○	2	17	✓		✓		✓	3½"x6¾"	50	50	5/10	11.6 lbs	0.30



CR2300

Register Rolls

Register Rolls provide a paper record of transactions at ATMs, POS printers and cash registers, hotels and restaurants, grocery stores and retailers. AmerCareRoyal offers quality receipt tape in 3 major styles: Bond, Carbonless and Thermal.

Carbonless Register Rolls

- Used to verify credit card charges in hotels and full-service restaurants, grocery stores and retailers
- 2-Ply receipt tape made from quality paper with a white or canary yellow customer copy
- Designed to fit ATMs, POS printers and cash registers

Width	Item	Color	Ply	Length	Core ID	Pack	Weight	Cube
1 3/4"	C175100100	☉	2	100'	7/16"	1/100	31.9 lbs	1.09
	C225085050	☉	2	85'	7/16"	1/50	18.4 lbs	0.66
2 1/4"	C225095050	☉	2	95'	7/16"	1/50	20.1 lbs	0.67
	CR2225	○	2	90'		4/10		
	RR2225	☉	2	90'		4/10	14.1 lbs	0.49
2 3/4"	C275095050	☉	2	95'	7/16"	1/50	24.8 lbs	0.88
	C3000650503P	☉	3	65'	7/16"	1/50	27.3 lbs	0.85
	C300092050	☉	2	92'	7/16"	1/50	26.3 lbs	0.88
3"	C300095050	☉	2	95'	7/16"	1/50	26.8 lbs	0.89
	CR2300	○	2	90'		3/10	16.1 lbs	0.59
	RR2300	○	2	90'		1/30	17.2 lbs	0.42
3 1/4"	C325095048	☉	2	95'	7/16"	1/48	26.7 lbs	0.77
4 1/2"	C450080040	☉	2	80'	7/16"	1/40		
	RR2450	○	2	90'		2/10	13.2 lbs	0.49

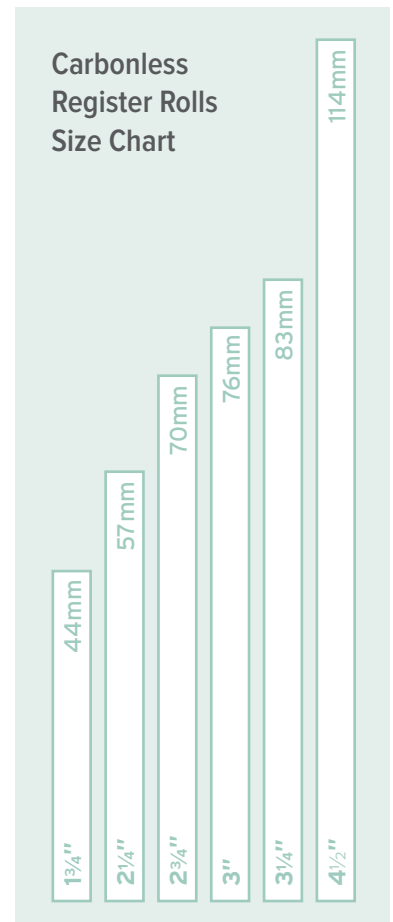

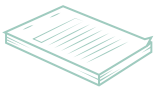

Guest Checks & Register Rolls

Thermal Register Rolls

- Made from quality heat sensitive paper that produces a black image from a thermal printer
- Fits many common credit, debit, POS machines, ATMs, cash registers and kitchen printers to generate an itemized receipt of the customer's transactions
- Offered in assorted widths, lengths and packaging

Width	Item	Color	Ply	Length	Core ID	Pack	Weight	Cube
1½"	T150150100	○		150'	7/16"	1/100	20.0 lbs	0.56
1¾"	T175200050	○		200'	7/16"	1/50	15.0 lbs	0.50
	TR7441	○	1	230'		5/10	17.9 lbs	0.69
2¼"	RR7225	○	1	200'		1/40	16.5 lbs	0.41
	RR7225SP	○	1	80'		1/48	8.0 lbs	0.23
	T225040032	○		40'	7/16"	1/32	2.9 lbs	0.10
	T225056050	○		56'	11mm	1/50	7.0 lbs	0.14
	T225064050	○		64'	7/16"	1/50	8.0 lbs	0.25
	T225074012	○		74'	11mm	1/12	1.7 lbs	0.05
	T225074050	○		74'	11mm	1/50	7.0 lbs	0.23
	T225080012	○		80'	7/16"	1/12	2.3 lbs	0.06
	T225080024	○		80'	7/16"	1/24	4.5 lbs	0.14
	T225080048	○		80'	7/16"	1/48	8.5 lbs	0.25
	T225080072	○		80'	7/16"	1/72	12.0 lbs	0.42
	T225095024	○		95'	1/2"	1/24	4.7 lbs	0.16
	T225150024	○		150'	7/16"	1/24	6.7 lbs	0.20
	T225165050	○		165'	7/16"	1/50	15.2 lbs	0.41
	T225200024	○		200'	7/16"	1/24	10.2 lbs	0.28
	T225200050	○		200'	7/16"	1/50	22.0 lbs	0.55
	T225218050	○		218'	1/2"	1/50	19.8 lbs	0.59
	T225250050	○		250'	7/16"	1/50	22.8 lbs	0.60
	TH225275012CSI	○		275'	11/16"	1/12	10.6 lbs	0.47
	TH225675008	○		675'	11/16"	1/8	16.8 lbs	0.46
TR7225	○	1	200'			4/10	15.3 lbs	0.31
TR7225SP	○	1	80'			2/24	11.5 lbs	0.25
2⅝"	T232200024	○		200'	7/16"	1/24	9.6 lbs	0.30
	T232400012	○		400'	11/16"	1/12	10.5 lbs	0.33
	T232435012	○		435'	11/16"	1/12	12.7 lbs	0.34
2⅞"	T234400012CSI	○		400'	1⅞"	1/12	10.9 lbs	0.29





Thermal Register Rolls - Continued

Width	Item	Color	Ply	Length	Core ID	Pack	Weight	Cube	
2 ³ / ₈ "	T238850012	○		850'	2"	1/12	23.0 lbs	0.68	
2 ⁷ / ₁₆ "	T244240024	○		240'	7/16"	1/24	13.0 lbs	0.36	
3"	T300200050	○		150'	7/16"	1/50	24.5 lbs	0.78	
	RR7313	○	1	200'		1/30	15.9 lbs	0.41	
	RR8313	○	1	200'		1/30	15.7 lbs	0.43	
	T318095024	○		95'	7/16"	1/24	6.8 lbs	0.22	
	T318119048	○		119'	7/16"	1/48	15.0 lbs	0.47	
	T318150050	○		150'	7/16"	1/50	20.3 lbs	0.59	
	T318230050	○		230'	7/16"	1/50	32.2 lbs	0.94	
	T318230050B	●		230'	7/16"	1/50	30.5 lbs	0.79	
	T318230050G	●		230'	7/16"	1/50	30.2 lbs	0.77	
	T318230050P	●		230'	7/16"	1/50	28.3 lbs	0.80	
	3 ¹ / ₈ "	T318230050Y	●		230'	7/16"	1/50	30.9 lbs	0.78
		T318273050	○		273'	7/16"	1/50	35.3 lbs	0.95
		TH318160050	○		160'	7/16"	1/50	34.2 lbs	0.94
		TH318195050	○		195'	7/16"	1/50	42.3 lbs	1.11
		TH318480008	○		480'	1"	1/8	17.0 lbs	0.52
		TH318480008CSI	○		480'	1"	1/8	15.6 lbs	0.44
		TH318600004	○		600'	2"	1/4	10.9 lbs	0.40
		TH318870008	○		870'	11/16"	1/8	29.5 lbs	0.73
		TH318870008CSI	○		870'	11/16"	1/8	27.8 lbs	0.76
		TR7313	○	1	200'		3/10	15.5 lbs	0.49
3 ⁵ / ₁₆ "	T323085050CSI	○		85'	7/16"	1/50	12.3 lbs	0.40	
	T323125050CSI	○		125'	7/16"	1/50	17.7 lbs	0.62	
4 ⁵ / ₁₆ "	T431095024	○		95'	7/16"	1/24	9.0 lbs	0.34	
	T431135024	○		135'	7/16"	1/24	12.5 lbs	0.39	
4 ³ / ₈ "	T438065024	○		65'	1/2"	1/24	6.8 lbs	0.24	
	T438315024	○		315'	1/2"	1/24	26.6 lbs	0.86	

Thermal Register Rolls Size Chart



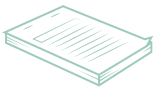

Guest Checks & Register Rolls

Bond Register Rolls

- Traditional, 1-Ply White Bond register receipt tape
- Quality bond paper fits ATMs, POS printers and cash registers
- Choose from various widths, lengths and bulk packaging

Width	Item	Color	Length	Core ID	Pack	Weight	Cube
1½"	B150150100	○	150'	7/16"	1/100	20.9 lbs	0.86
	BR1381	○	130'		5/10	11.8 lbs	0.50
	RR1381	○	130'		5/10	16.8 lbs	0.59
1¾"	B175150100	○	150'	7/16"	10/10	24.0 lbs	0.97
	B175190100	○	190'	7/16"	10/10	31.4 lbs	1.08
	BR1441	○	130'		5/10	12.5 lbs	0.49
2¼"	RR1441	○	130'		1/50	14.7 lbs	0.42
	B225150050	○	150'	7/16"	1/50	16.6 lbs	0.58
	BR1225	○	130'		4/10	13.0 lbs	0.48
2¾"	RR1225	○	130'		1/40	13.7 lbs	0.41
	B275165050	○	165'	7/16"	1/50	22.5 lbs	0.85
	B275190050	○	190'	7/16"	1/50	24.9 lbs	0.85
3"	B300095050	○	95'	7/16"	1/50	13.5 lbs	0.58
	B300165050	○	165'	7/16"	1/50	23.0 lbs	0.77
	B300165050B	●	165'	7/16"	1/50	23.5 lbs	0.91
	B300165050G	●	165'	7/16"	1/50	24.4 lbs	0.84
	B300165050P	●	165'	7/16"	1/50	24.7 lbs	0.83
	B300165050Y	●	165'	7/16"	1/50	24.1 lbs	0.79
	B300190050	○	190'	7/16"	1/50	27.7 lbs	0.92
	BR1300	○	150'		3/10	13.6 lbs	0.50
	RR1300	○	150'		1/30	18.6 lbs	0.49
3¼"	BR1325	○	165'		3/10	17.3 lbs	0.59
	B325215048	○	215'	7/16"	1/48	30.7 lbs	1.02
	RR1325	○	165'		3/10	16.6 lbs	0.49
4½"	B450150040	○	150'	7/16"	1/40	28.0 lbs	0.96
	RR1450	○	160'		2/10	10.7 lbs	0.49

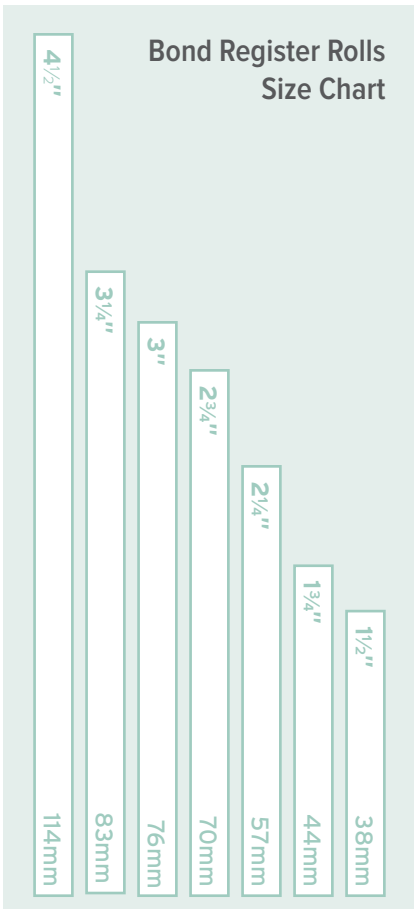



Ink Ribbons

- Essential items to any POS transaction to help keep receipts printing clearly
- High-quality ink ribbons from AmerCareRoyal are designed to fit most common brand printer

Item	Color	Description	Pack	Weight	Cube
CT12334CBR	●	Universal Calculator Spool	1/12	1.5 lbs	0.10
CT1252023B	●	Epson ERC23	1/12	1.5 lbs	0.10
CT1252023BR	●	Epson ERC23	1/12	1.0 lbs	0.17
CT1252023P	●	Epson ERC23	1/12	1.5 lbs	0.10
CT1252027P	●	Epson ERC27	1/12	1.5 lbs	0.10
CT1252030B	●	Epson ERC30/ERC34/ERC38	1/12	1.0 lbs	0.15
CT1252030P	●	Epson ERC30/ERC34/ERC38	1/12	1.1 lbs	0.20
CT1252031P	●	Epson ERC31	1/12	1.9 lbs	0.29
CT1252200B	●	Star SP200/Star SP500	1/12	0.9 lbs	0.19
CT1252200BR	●	Star SP200/Star SP500	1/12	1.0 lbs	0.16
CT1252200P	●	Star SP200/Star SP500	1/12	1.0 lbs	0.15
CT1255164P	●	Epson ERC09/HX20	1/12	1.5 lbs	0.10
CT652004B	●	Olivetti PR4	1/6	0.7 lbs	0.06
CT652018P	●	Epson ERC18	1/6	0.9 lbs	0.07
CT652030BR	●	Epson ERC30	1/6	0.5 lbs	0.06
CT652032P	●	Epson ERC32	1/6	0.7 lbs	0.12
CT652039P	●	Epson ERC39	1/6	0.7 lbs	0.06
CT652300B	●	Star SP300	1/6	0.8 lbs	0.08
CT652300P	●	Star SP300	1/6	0.7 lbs	0.09
CT652400P	●	Casio CE4000/Citizen DP700/IR-71	1/6	0.7 lbs	0.06
CT652500P	●	Epson ERC03	1/6	0.7 lbs	0.06
CT652700BR	●	Citizen DP600/IR-61	1/6	0.7 lbs	0.09
CT652700P	●	Citizen DP600/IR-61	1/6	0.7 lbs	0.06
CT652900BR	●	Verifone 900	1/6	0.7 lbs	0.06
CT655118B	●	Citizen 120D/GSX 140	1/6	0.7 lbs	0.06
CT657105P	●	DH Print/Eaton 4400	1/6	0.7 lbs	0.06



CT1252027P



CT1255164P



CT652400P



CT655118B





HEADWEAR & HAIR RESTRAINTS

AmerCareRoyal's comprehensive disposable headwear, hairnet, and beard protection line provide economical and practical solutions that help your operation comply with sanitation and food preparation standards.

Our wide selection of chef hats, caps and beard protection styles are constructed with high-quality materials. They are ideal for any food service establishment.

Beanie Caps.....	71
Chef Hats.....	72
Paper Caps	72
Hair Nets	73
Beard Protectors	75
Bouffant Caps.....	76



Headwear & Hair Restraints



BC100BKS

Headwear & Hair Restraints

AmerCareRoyal's comprehensive disposable headwear, hairnet and beard protection collection provides an economical and practical solution will help your operation comply with FDA Food Code 2-402.11 regarding safe food handling and preparation standards.

Our wide selection of chef hats, caps and beard protection styles are constructed with high-quality materials are ideal for any size establishments.

Beanie Caps

AmerCareRoyal's beanie caps are lightweight, breathable, disposable and a great alternative to expensive cloth or rarely washed baseball caps. Our beanie caps will help maintain a food safe environment in your restaurant, kitchen, food truck, wholesale, catering or food processing environment and give a contemporary style to your kitchen or serving staff.

Item	Color	Size	Pack	Weight	Cube
BC100BKS	●	S	2/50	2.7 lbs	0.51
BC100BKL	●	L	2/50	2.7 lbs	0.51
BC100NBS	●	S	2/50	2.7 lbs	0.51
BC100NBL	●	L	2/50	2.7 lbs	0.51
BC100WS	○	S	2/50	2.7 lbs	0.51
BC100WL	○	L	2/50	2.7 lbs	0.51



Chef Hats

Keep your operation looking authentic with AmerCareRoyal chef's hats! Our line of disposable hats are built for food establishments and look great in front of your guests. Choose from a variety of styles that fit the ambiance of your establishment.



Paper Chef Hats

- Pleated and fluted styles are ready to wear and feature a unique sweatband with a convenient peel and stick adjustable tab for correct sizing
- Flat pack are unassembled fluted style hats with open tops for better circulation and a peel and stick adjustable size tab

Style	Item	Color	Size	Open Top	Pack	Weight	Cube
Fluted	SCH7	○	7"		1/15	2.0 lbs	1.18
	SCH9	○	9"		1/12	2.0 lbs	1.18
	SCH10	○	10"		1/12	2.0 lbs	1.18
	SCH12	○	12"		1/12	3.0 lbs	1.93
Pleated	RCH7	○	7"		1/28	2.8 lbs	1.04
	RCH9	○	9"		1/24	2.9 lbs	1.30
	RCH10	○	10"		1/24	2.9 lbs	1.43
	RCH12	○	12"		1/24	3.3 lbs	1.52
Flat Pack	RFP7	○	7"	✓	1/50	4.0 lbs	0.54
	RFP9	○	9"	✓	1/50	4.2 lbs	0.59
	RFP10	○	10"	✓	1/50	4.5 lbs	0.59



Viscose Chef Hats

- Made from a strong, durable, non-woven material for a comfortable, longer wear time

Style	Item	Color	Size	Open Top	Pack	Weight	Cube
Pleated	VCH9	○	9"		1/50	3.8 lbs	0.69
	VCH12	○	12"		1/50	4.5 lbs	0.81
Flat Pack	VCH8S	○	8"	✓	1/50	3.1 lbs	0.42

Paper Caps

- Soft, white crepe paper in adjustable sizes
- Classy Caps have low crown, Overseas have high crown



Style	Item	Color	Pack	Weight	Cube
Classy Low Crown	RCC2	●	10/100	23.8 lbs	1.06
	RCC2A	●	10/100	23.8 lbs	1.06
	RCC2C	●	10/100	23.8 lbs	1.06
	RCC2W	○	10/100	23.8 lbs	1.06
Overseas High Crown	RPOS1	●	10/100	24.6 lbs	2.05
	RPOS1A	●	10/100	24.6 lbs	2.05
	RPOS1W	○	10/100	24.6 lbs	2.05



Headwear & Hair Restraints



RPH100W

Hairnets

Latex free nylon hairnets offer a comfortable and sanitary food barrier from hair contamination. The breathable and fire-retardant nylon netting is nearly invisible and helps avoid undesirable and unsanitary contamination.

Honeycomb Style Hairnets

- Made of soft nylon and are a strong, comfortable barrier from hair contamination
- Designed to provide less material shedding while blocking particulates for added protection
- Inner poly bag packaging

Invisible Style Hairnets

- Latex free, 100% nylon heavyweight hairnets
- Comfortable and sanitary food protection barrier from hair contamination
- Each piece individually packed in a paper sleeve inside a dispensing box



Hairnets

Style	Item	Color	Size (in)	Pack	Weight	Cube
Honeycomb	RPH100BK	●	18	10/100	5.5 lbs	0.76
	RPH100DB	●	18	10/100	5.5 lbs	0.76
	RPH100W	○	18	10/100	5.5 lbs	0.76
	RPH100B21	●	21	10/100	7.1 lbs	0.83
	RPH100BK21	●	21	10/100	7.1 lbs	0.83
	RPH100BR21	●	21	10/100	7.1 lbs	0.83
	RPH100W21	○	21	10/100	7.1 lbs	0.83
	RPH100B24	●	24	10/100	7.3 lbs	1.00
	RPH100BK24	●	24	10/100	7.3 lbs	1.00
	RPH100BR24	●	24	5/100	7.3 lbs	1.00
	RPH100W24	○	24	10/100	7.3 lbs	1.00
	RPH100W26	○	26	10/100	8.8 lbs	1.00
Lightweight	RPH144LTBK	●	24	20/144	7.5 lbs	0.74
	RPH144LTDB	●	24	20/144	7.5 lbs	0.74
	RPH144LTLB	●	24	20/144	7.5 lbs	0.74
	RPH144LTW	○	24	20/144	7.5 lbs	0.74
	RPH144LTBK28	●	28	20/144	7.7 lbs	0.74
	RPH144LTDB28	●	28	20/144	7.7 lbs	0.74
	RPH144LTLB28	●	28	20/144	7.7 lbs	0.74
	RPH144LTW28	○	28	20/144	7.7 lbs	0.74
Heavyweight	RPH144HD	●	20	10/144	5.6 lbs	1.00
	RPH144HDBK	●	20	10/144	5.6 lbs	1.00
	RPH144HD25	●	25	10/144	5.6 lbs	1.06
	RPH144HDBK25	●	25	10/144	5.6 lbs	1.06

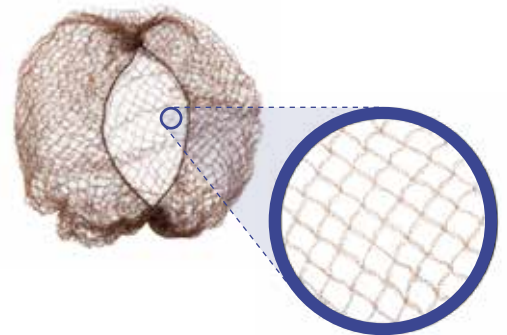
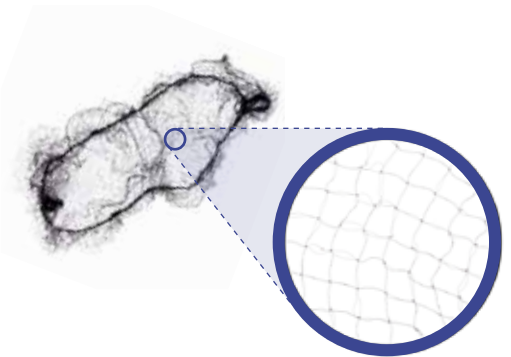
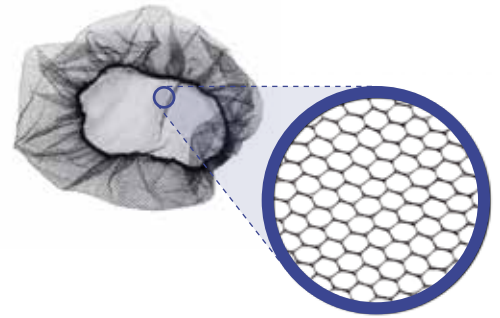

Hairnet Dispensers

- Ideal for use in food processing and industrial facilities
- Hinged lid and bottom slit provide convenient, one-at-a-time dispensing, while helping prevent contamination
- Great for hairnets, bouffant caps or beard protectors

Item	Size	Pack	Weight	Cube
RPHDS	4"x3.5"x5.5"	1/1	1.0 lbs	0.28
RPHDM	8"x3.5"x10.5"	1/1	1.7 lbs	0.35
RPHDL	12"x5"x12"	1/1	3.4 lbs	1.37





Headwear & Hair Restraints



RBP1M

Polypropylene Hood

Item	Color	Pack	Weight	Cube
RPPH100	○	10/100	8.3 lbs	1.22



Beard Protectors

AmerCareRoyal's beard protectors are latex free and provide an ideal facial hair and particulate barrier from contaminating food, equipment and manufactured items. Available in economical, lightweight polypropylene and stronger nylon honeycomb netting for complete beard coverage with a comfort fit.

Nylon Honeycomb

- Soft nylon and aperture provide less material shredding while blocking more particulate
- Breathable open weave material provides a lasting comfort fit
- Great for use in institutional foodservice, food processing facilities, industrial settings and more

Polypropylene

- Economical particulate barrier protection for all day use
- Cost effective choice for sanitary protection
- Great for use in institutional foodservice, food processing facilities, industrial settings and more

Beard Protectors

Material	Item	Color	Size	Pack	Weight	Cube
Nylon	RBP1MN	○	18"	10/100	4.0 lbs	0.52
	RBP1MNB	●	18"	10/100	4.0 lbs	0.52
	RBP1MNDB	●	18"	10/100	4.0 lbs	0.52
Polypropylene	RBP1M	○	18"	10/100	3.7 lbs	0.46
	RBP1MXL	○	21"	10/100	3.9 lbs	0.68



RBP1MN



Bouffant Caps

AmerCareRoyal's lightweight spun bond polypropylene bouffant caps provide complete, reliable sanitary protection.

Style	Item	Color	Size	Pack	Weight	Cube	
Non-Pleated	RP110NW19	○	19"	10/100	5.1 lbs	0.83	
	RP110NWB19	●	19"	10/100	5.1 lbs	0.83	
	RP110NWC19	●	19"	10/100	5.1 lbs	0.83	
	RP110NWC519	●	19"	5/100	3.0 lbs	1.02	
	RP110NW	○	21"	10/100	6.0 lbs	0.90	
	RP110NW5	○	21"	5/100	2.9 lbs	0.51	
	RP110NWA	●	21"	10/100	6.0 lbs	0.90	
	RP110NWB	●	21"	10/100	6.0 lbs	0.90	
	RP110NWC	●	21"	10/100	6.0 lbs	0.90	
	RP110NWC5	●	21"	5/100	3.4 lbs	1.02	
	RP110NWNB	●	21"	10/100	5.5 lbs	0.90	
	RP110NWO	●	21"	10/100	5.5 lbs	0.90	
	RP110NWY	●	21"	10/100	6.0 lbs	0.90	
	RP110NW24	○	24"	10/100	6.1 lbs	0.99	
	RP110NWA24	●	24"	10/100	6.1 lbs	0.99	
	RP110NWB24	●	24"	10/100	6.1 lbs	0.99	
	RP110NWC24	●	24"	10/100	6.1 lbs	0.99	
	RP110NWNB24	●	24"	10/100	7.2 lbs	0.99	
	RP110NWO24	●	24"	10/100	7.2 lbs	0.99	
	RP110NWY24	●	24"	10/100	6.1 lbs	0.99	
	RP110NW28	○	28"	10/100	9.2 lbs	1.45	
	Pleated	RP110NWP	○	21"	10/100	6.6 lbs	0.94
		RP110NWPB	●	21"	10/100	6.6 lbs	0.94
		RP110NW24P	○	24"	10/100	7.7 lbs	1.06
RP110NW24BP		●	24"	10/100	7.7 lbs	1.06	
Shower Cap	RP110PE5	⊗	21"	5/100	5.3 lbs	0.67	



Non-Pleated Bouffant Caps

- Comfortable, economical, clean room compatible
- High quality particulate barrier in a non-toxic workplace
- Great for use in commercial foodservice and industrial food processing, pharmaceutical production and electronic device assembly

Pleated Bouffant Caps

- Machine made pleated bouffant caps provide added and consistent sanitary coverage
- Lightweight, breathable fabric perfect for all day use
- Great for use in commercial foodservice and industrial food processing, pharmaceutical production and electronic device assembly



There are 10 beards and 10 eyes hidden in this picture. Can you find all of them?



KIDS' PRODUCTS

Kids can have a great deal of influence on their parents' decision where to dine out. It is important the restaurant operators appeal to their younger guests with attractive and amusing mealtime essentials like color pictures and activity sheets. If the kids have a fun experience, so will their parents, and the whole family can enjoy quality time in your restaurant!

Crayons	79
Kids' Bibs & Kaps.....	79
Kids' Cups	80
Placemats	80





Kids' Products

Crayons

- Entertained kids = happy parents
Happy parents = satisfied customers
- Lead and asbestos free
- Also available: hex-shaped crayons that won't roll away from little hands ...and off the table
- Various pack sizes and colors available



NO ROLL DESIGN

Item	Color	Premium	Honeycomb	Placemat Kit	Cello Wrapped	Boxed	Bulk	Size	Pack	Weight	Cube
CR20002PKP	● ● ● ●				✓			2 Pack	2/1000	19.8 lbs	0.51
CR20004PKP	● ● ● ●				✓			4 Pack	4/500	19.8 lbs	0.56
CR21603PKP	● ● ●				✓			3 Pack	3/720	22 lbs	0.59
CR30004BK	● ● ● ●						✓	4 Color	1/3000	31.9 lbs	0.62
CR30006BKP	● ● ● ● ● ●	✓					✓	6 Color	1/3000	31.3 lbs	0.72
CRH20004BXP	● ● ● ●	✓	✓			✓		4 Color	4/500	24.4 lbs	0.68
CRH20004PKP	● ● ● ●		✓		✓			4 Pack	4/500	22 lbs	0.66
CRH30006BKP	● ● ● ● ● ●	✓	✓				✓	6 Color	6/500	31.6 lbs	0.71



Kids Bibs

- Protect children's clothing while they are eating foods such as ice cream, pasta and soup
- AmerCareRoyal's catch pocket design and large "safe" areas helps to keep clothes clean

Item	Material	Theme	Pack	Weight	Cube
CPB10	Poly	Clown	5/500	18.3 lbs	0.9



We've got Adult Kaps, too!
Page 72

Kids Kaps

- Great novelty item for kids to color and wear
- Soft, white crepe paper with fish and animal designs
- Fun alternatives to coloring ordinary placemats
- Adjustable in size

Item	Material	Theme	Pack	Weight	Cube
RCC2KK	Paper	Animals	10/100	23.8 lbs	1.06



Kids Placemats

- Choose from a selection of coloring placemat options or activity sheets
- Made from recycled paper
- Double sided

Item	Theme	Pack	Weight	Cube
AS1000AT	Zoo Animals	1/1000	17 lbs	0.45
AS1000CT	Camping/Southwest	1/1000	14.4 lbs	0.53
AS1000GR	Green	1/1000	14.3 lbs	0.44
AS1000MX	Mixed	1/1000	17 lbs	0.45
AS1000OS	Outerspace	1/1000	15 lbs	0.48
AS1000PG	Playground	1/1000	13.2 lbs	0.83
AS1000RR	Rock N Roll	1/1000	14.3 lbs	0.52
AS1000SP	Sports	1/1000	14.2 lbs	0.44
AS1000ST	Sea	1/1000	17 lbs	0.45
CK125*	Mixed	1/125	12 lbs	0.4
PM1000AT2	Animals	1/1000	14.8 lbs	0.49
PM1000IT2	Italian	1/1000	15.4 lbs	0.47
PM1000MT2	Mexican	1/1000	15.6 lbs	0.48
PM1000MX	Mixed	1/1000	15.7 lbs	0.48
PM1000WT2	Western	1/1000	15.5 lbs	0.48

* Kit includes 125 crayon 4-packs



Kids Cups

- Available in Imagination, Mexican, and Jungle Friends themes
- Lids and straws for maximum convenience
- Take home and reuse

Item	Theme	Ounces	Pack	Weight	Cube
KCT250IT	Imagination	12	1/250	10.7 lbs	1.15
KCT250JF	Jungle Friends	12	1/250	10.7 lbs	1.15
KCT250MT	Mexican	12	1/250	10.7 lbs	1.15







NAPKINS

Protect your guests' hands and laps while adding style to table settings and to go orders with AmerCareRoyal's large selection of quality napkins. Choose from air laid, dinner, beverage and multiple fold options. Available in a variety of sizes and colors, these napkins offer a versatile disposable option.

Airlaid Napkins	83
Dinner Napkins	83
Beverage Napkins.....	84
Dispenser Napkins	84
Napkin Bands	85
Placemats	87
Bibs.....	89
Doilies.....	90



Napkins

Airlaid Napkins

- Used for wrapping cutlery or laying neatly on the table
- Soft to the touch and deliver a sophisticated appeal
- More durable and absorbent than traditional paper napkins

Item	Color	Flat Size	Fold	Pack	Weight	Cube
LN1414-F	○	14" X 14"	Flat	1/1000	13.6 lbs	1.88
LN1517-8	○	15" X 17"	1/8	10/50	11 lbs	1.5
LN1616-F	○	16" X 16"	Flat	1/1000	19.7 lbs	2.13
LN1717-8	○	17" X 17"	1/8	6/50	8.2 lbs	1.08
LT1217-6	○	12" X 17"	1/6	5/100	8.8 lbs	1.09
NKA1P1516	○	15" X 16"	Flat	1/1000	20.5 lbs	2.33

Common Folds with a Flat Napkin



Types of Folds

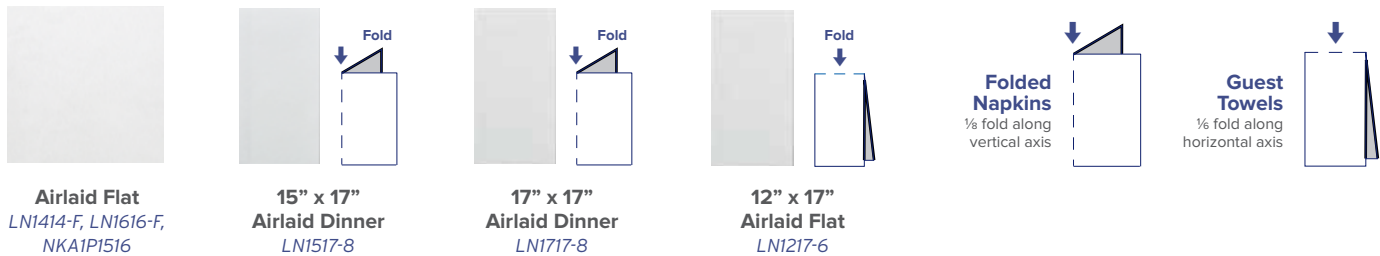

Dinner Napkins

- 2-ply design lets you roll, wrap or fold for every table setting
- Feature a coin edge embossing pattern
- Available in a variety of colors for restaurants, bars, caterers and other food serving locations
- Retail friendly inner packaging

Item	Color	Ply	Flat Size	Folded Size	Pack	Weight	Cube
DNAP1M-BK	●	2	15" X 17"	4¼" X 7½"	8/125	12.9 lbs	1.07
DNAP1M-DC	●	2	15" X 17"	4¼" X 7½"	8/125	12.9 lbs	1.07
DNAP1M-PUR	●	2	w15" X 17"	4¼" X 7½"	8/125	12.9 lbs	1.07
DNAP1M-R	●	2	15" X 17"	4¼" X 7½"	8/125	12.9 lbs	1.07
DNAP1M-T	●	2	15" X 17"	4¼" X 7½"	8/125	12.9 lbs	1.07
DNAP1M-W	○	2	15" X 17"	4¼" X 7½"	8/125	12.9 lbs	1.07
DNAP1M-YEL	●	2	15" X 17"	4¼" X 7½"	8/125	12.9 lbs	1.07
NK1P1517	○	1	15" X 17"	4¼" X 7½"	12/250	36 lbs	1.46
NK2P1517	○	2	15" X 17"	4¼" X 7½"	20/150	25.4 lbs	2.16
NK1P1717	○	1	16½" X 16½"	8¼" X 8¼"	8/500	27.1 lbs	2.56
NK2P1717	○	2	16½" X 16½"	8¼" X 8¼"	12/250	34.5 lbs	3.3
NK3P1717	○	3	16½" X 16½"	8¼" X 8¼"	20/100	33.1 lbs	3.34



Black



Dark Green



Purple



Red



Teal



White



Yellow

Beverage Napkins

- Available in a variety of colors for restaurants, cafes, bars and more
- Cost effective option for snacks and small appetizers instead of plates
- Absorbent 2-ply design for added strength
- Kraft is 1-ply only & made with 100% recyclable tissue paper
- Subtle embossed texture provides a touch of flair

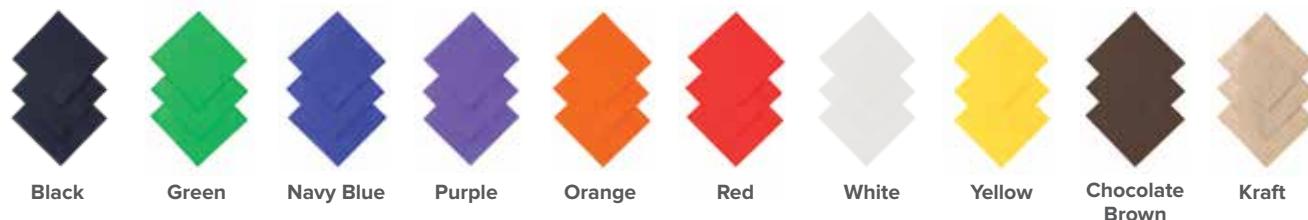

Item	Color	Ply	Flat Size	Folded Size	Pack	Weight	Cube
NK1P99	○	1	9" X 9"	4½" X 4½"	8/500	9.8 lbs	0.83
NK2P1010BK	●	2	9½" X 9½"	4¾" X 4¾"	5/200	6 lbs	0.55
BEVNAP1M-BK	●	2	10" X 10"	5" X 5"	5/200	5.5 lbs	0.46
BEVNAP1M-CB	●	2	10" X 10"	5" X 5"	5/200	5.5 lbs	0.46
BEVNAP1M-G	●	2	10" X 10"	5" X 5"	5/200	5.5 lbs	0.46
BEVNAP1M-N	●	1	10" X 10"	5" X 5"	5/200	3.4 lbs	0.29
BEVNAP1M-NB	●	2	10" X 10"	5" X 5"	5/200	5.5 lbs	0.46
BEVNAP1M-O	●	2	10" X 10"	5" X 5"	5/200	5.5 lbs	0.46
BEVNAP1M-PUR	●	2	10" X 10"	5" X 5"	5/200	5.5 lbs	0.46
BEVNAP1M-R	●	2	10" X 10"	5" X 5"	5/200	5.5 lbs	0.46
BEVNAP1M-W	○	2	10" X 10"	5" X 5"	5/200	5.5 lbs	0.46
BEVNAP1M-YEL	●	2	10" X 10"	5" X 5"	5/200	5.5 lbs	0.46
NK1P1113	○	1	11¼" X 13"	5⅝" X 6½"	12/500	25.5 lbs	2.28

Dispenser Napkins

- Dispenser napkins have a mid-fold design and are perfect for use with napkin dispensers
- Economical embossed construction
- Great for any restaurant, event or caterers looking for a convenient and disposable napkin option



Item	Color	Ply	Flat Size	Fold	Pack	Weight	Cube
NK2P865	○	2	7 ¹³ / ₁₆ " X 6½"	1/2	24/500	17.5 lbs	1.97
NKR2P865	●	2	7 ¹³ / ₁₆ " X 6½"	1/2	24/500	17.5 lbs	1.89
NK1P1312	○	1	13" X 12"	1/8	20/300	24 lbs	2.54



Napkin Bands

- Paper napkin bands allow staff members to pre-wrap utensils during downtime to keep utensils covered and secure
- Available in a wide variety of colors, providing your business with a clean appearance



Color	Item	Shrink Wrap Packing	Box Packing	Pack	Weight	Cube
● Black	NB10000BK		✓	4/2500	7.5 lbs	0.22
	RNB20MBK		✓	8/2500	20.9 lbs	0.49
	RNB4MBK		✓	2/2000	4 lbs	0.11
○ White	NB10000W		✓	4/2500	7.4 lbs	0.23
	RNB10M		✓	4/2500	10.4 lbs	0.26
	RNB20M		✓	8/2500	20.5 lbs	0.49
	RNB20MSW	✓		8/2500	20.9 lbs	0.48
	RNB4M		✓	2/2000	4 lbs	0.11
	RNB5M		✓	2/2500	5.3 lbs	0.14
● Blue	NB10000BL		✓	4/2500	7.5 lbs	0.22
	RNB20ME		✓	8/2500	20.9 lbs	0.5
● Brown	RNB20MK		✓	8/2500	20.9 lbs	0.49
● Burgundy	NB10000B		✓	4/2500	7.3 lbs	0.22
	RNB20MN		✓	8/2500	21.2 lbs	0.48
	RNB4MN		✓	2/2000	4 lbs	0.11
● Green	NB10000G		✓	4/2500	7.9 lbs	0.23
	RNB20MC		✓	8/2500	20.9 lbs	0.42
● Hunter Green	RNB20MHC		✓	8/2500	20.9 lbs	0.49
	RNB4MHC		✓	2/2000	4 lbs	0.11
● Kraft	RNB4MNK		✓	2/2000	4 lbs	0.11
● Navy Blue	RNB20MNB		✓	8/2500	20.9 lbs	0.49
● Red	NB10000R		✓	4/2500	7.4 lbs	0.22
	RNB20MA		✓	8/2500	20.9 lbs	0.49
● Rust	RNB20ML		✓	8/2500	20.9 lbs	0.5
● Teal	RNB20MT		✓	8/2500	20.9 lbs	0.48





Napkins



SPM914DC

Placemats

- Add fun and color to table settings with AmerCareRoyal's selection of placemats
- Protect surfaces and spills, scuffs and stains
- Scalloped and embossed styles available
- Available in printed designs, white placemats and tray covers, and bright solid colors
- Great for use in restaurants, diners, hospitals, institutional cafeterias and much more

Solid Color Placemats

Newsprint Paper with Scalloped Edge

Item	Color	Size	Pack	Weight	Cube
SPM914A	●	9½" X 13½"	1/1000	8.6 lbs	0.3
SPM914BK	●	9½" X 13½"	1/1000	8.6 lbs	0.3
SPM914C	●	9½" X 13½"	1/1000	8.6 lbs	0.3
SPM914DC	●	9½" X 13½"	1/1000	8.6 lbs	0.3
SPM914E	●	9½" X 13½"	1/1000	8.6 lbs	0.3
SPM914G	●	9½" X 13½"	1/1000	8.6 lbs	0.3
SPM914N	●	9½" X 13½"	1/1000	8.6 lbs	0.3
SPM914P	●	9½" X 13½"	1/1000	8.6 lbs	0.3
SPM914Q	○	9½" X 13½"	1/1000	8.6 lbs	0.3



White Placemats and Traymats

Premium Bond Paper - Embossed Texture

Item	Size	Scalloped	Straight Edge	Decorative Embossing	Pack	Weight	Cube
W1014	10" X 14"		✓	✓	1/1000	10.7 lbs	0.44
W1014E	10" X 14"		✓		1/1000	11.5 lbs	0.27
W1216S	12¾" X 16½"	✓			1/1000	13.7 lbs	0.64
W1419S	14" X 19"		✓		1/1000	18.7 lbs	0.87
WSS914	9½" X 13½"	✓			1/1000	9.5 lbs	0.39



Printed Placemats

Item	Theme	Size	Scalloped	Straight Edge	Round Corners	Newsprint	Groundwood	Premium Bond	Pack	Weight	Cube
PM171	Greek Key	10" X 14"		✓			✓		1/1000	10 lbs	0.44
PM6000	Gold Border	10" X 14"			✓			✓	1/1000	12 lbs	0.27
PM805-2	Chinese Zodiac	10" X 14"		✓		✓			1/1000	10 lbs	0.38
PMCROC-4	Crocodile	9½" X 13½"	✓			✓			1/1000	8.2 lbs	0.27
PMFLB-4	Florida	9½" X 13½"	✓			✓			1/1000	8.2 lbs	0.27
PMFLW-4	Flowers	9½" X 13½"	✓			✓			1/1000	8.2 lbs	0.27
PMFNG-4	Fun Games	9½" X 13½"	✓			✓			1/1000	8.2 lbs	0.27
PMFTS-2G	Find The States	10" X 14"		✓			✓		1/1000	11 lbs	0.27
PMINDIA-4	India	9½" X 13½"	✓			✓			1/1000	8.2 lbs	0.27
PMITALY-4	Facts About/Map Of Italy	9½" X 13½"	✓			✓			1/1000	8.2 lbs	0.27
PMITALY-4G	Facts About Italy	10" X 14"		✓			✓		1/1000	11 lbs	0.27
PMMEX-4	Mexican Fiesta	9½" X 13½"	✓			✓			1/1000	8.2 lbs	0.27
PMSPAG-4	Spaghetti	9½" X 13½"	✓			✓			1/1000	8.2 lbs	0.27
PMSPORT-4	Sports	9½" X 13½"	✓			✓			1/1000	8.2 lbs	0.27





Napkins



ATB-WHITE

Bibs

AmerCareRoyal's Polyethylene and Paper Bibs allow your customers to enjoy their meal worry-free. Being lightweight and comfortable makes them an ideal choice for restaurants, hospitals and other institutions.

Poly Bibs

- Tie being the neck providing inexpensive protection to keep dining customers clean
- Extremely light weight allows for comfortable wear throughout the meal

Paper Bibs

- Super absorbent, white crepe paper prevents runoff
- Laminated poly backing prevents spills from leaking through onto clothing



Material	Item	Design/Color	Size	Pack	Weight	Cube
Poly	PBW	○	Adult	1/500	7.3 lbs	0.39
	PB25	Lobster	Adult	5/500	37.5 lbs	2.01
	PB24	Crab	Adult	5/500	37.5 lbs	2.14
Paper	ATB-WHITE	○	Adult	1/500	12.1 lbs	1.41
	ATB-LOBS	Lobster	Adult	1/500	12.1 lbs	1.41
	ATB-CRAB	Crab	Adult	1/500	12.1 lbs	1.41



Doilies

- Round lace paper doilies add an elegant touch to any setting
- Offered in multiple round sizes and feature a lacey outer design with an embossed center
- Made from 60 lb. unbleached white bond paper for superior durability, less shredding and easy de-nesting
- Individually shrink-wrapped packaging prevents yellowing, curling and ensures a long shelf life

Item	Size	Pack	Weight	Cube
LD4	4"	10/1000	7.8 lbs	0.52
LD5	5"	10/1000	11.7 lbs	0.73
LD6	6"	10/1000	17.4 lbs	1.05
LD7	7"	10/1000	24.1 lbs	1.11
LD8	8"	10/500	15.1 lbs	0.8
LD9	9"	10/500	20.8 lbs	1.16
LD10	10"	10/500	22.8 lbs	1.2
LD12	12"	10/500	33.5 lbs	1.69
LD14	14"	10/250	25.7 lbs	1.56
LD16	16"	10/250	30.8 lbs	2.17
LD18	18"	4/250	17.2 lbs	0.99

Wipes & Towelettes

Fingerbowls/Moist Towelettes

- Clean, fresh lemon scent
- Excellent for customers order messy foods such as wings, ribs and more

Item	Pack	Weight	Cube
RF1MB	1/1000	6.5 lbs	0.37



Ultimate Fingerbowl

Disposable Hot/Cold Pre-Moistened Wipe

- Large heavyweight pre-moistened towel
- Strong enough for the toughest messes but soft and gentle enough for your hands and face
- Fresh lemon scent
- Place them in the microwave for a smoothing warm towel or in the refrigerator for a refreshing cool wipe

Item	Pack	Weight	Cube
RF1MU	1/250	6.3 lbs	0.51



First Aid Towelette

Contains Benzalkonium Chloride, an effective antiseptic agent that kills and inhibits the growth of disease causing bacteria

- Safe for sensitive skin and does not sting
- Cleansing & refreshing
- Fresh lemon scent

Item	Pack	Weight	Cube
RF1MA	10/100	6 lbs	0.35





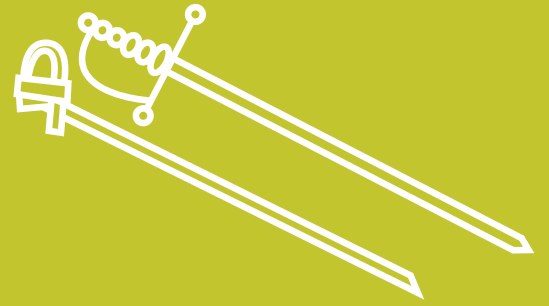

PICKS & SKEWERS

Enhance hors d'oeuvres, kabobs, sandwiches, appetizers, deli trays, beverages and more with AmerCareRoyal's wide variety of picks and skewers. Made from premium materials, these are constructed from sturdy quality plastic or splinter-free wood and bamboo. Perfect for restaurants, cafés, diners, catering events, parties, food service locations for any occasion.

Arrow Picks	93
Flag Picks.....	93
Sword Picks.....	93
Bamboo Picks	94
Party Picks.....	94
Toothpicks.....	94
Skewers	95
Steak Markers.....	96

Picks & Skewers

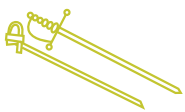

Picks

Arrow Picks

- Add festive color to food and beverages
- Perfect for sandwiches, appetizers and beverages, or for retrieving cocktail cherries, olives and more
- Made from heavier weight plastic – stronger than traditional arrow picks



Item	Color	Premium	Pack	Weight	Cube
RP148PBK	●	✓	10/1000	10.6 lbs	0.35
RP148P	○ ● ● ● ●	✓	10/1000	11 lbs	0.4
RP148BK	●		10/1000	5.7 lbs	0.22
RP148	○ ● ● ● ●		10/1000	5.7 lbs	0.23

Sword Picks

- Sword picks create a lively atmosphere in restaurants or outdoor gatherings
- Add festive color to food and beverages
- Perfect for sandwiches, appetizers and beverages, or retrieving cocktail cherries, olives and more



Size	Item	Color	Pack	Weight	Cube
3.25"	RP147	○ ● ● ● ●	10/1000	9 lbs	0.75
	RP147BK	●	10/1000	9 lbs	0.76
4.5"	RP147-45	○ ● ● ● ●	5/500	4.9 lbs	0.36
	RP147-45BK	●	4/500	5 lbs	0.9

Prism Picks

- Triangular shaped prism picks boast a contemporary look and feel
- Constructed with a pointed tapered end for ease of use
- Perfect for martinis or specialty drinks



Size	Item	Color	Pack	Weight	Cube
4"	RP149-4BK	●	5/500	4.9 lbs	0.11
	RP149-4C	○	5/500	4.9 lbs	0.11
6"	RP149-6BK	●	5/500	7.1 lbs	0.2
	RP149-6C	○	5/500	7.1 lbs	0.2

Flag Picks

- Gives meals a festive feel
- Perfect for enhancing the look of appetizers or small food items
- Choose from Mexican, Italian, and American flag designs

Item	Description	Pack	Weight	Cube
R827	American Flag Picks	20/10/100	18.7 lbs	1.06
R829	Italian Flag Picks	100/144	11.9 lbs	0.61
R830	Mexican Flag Picks	10/10/144	12.6 lbs	0.7



Front of house

Toothpicks

AmerCareRoyal Toothpicks are made from choice white birch and all-natural renewable resources to assure these items are compostable and biodegradable.

Our strong and durable toothpicks are perfect for any occasion and available in a selection of styles such as:

- Individually paper or cello wrapped
- Plain
- Mint
- Carved Kokeshi



Bamboo Picks

- Choose from bamboo knot, paddle, display, and assorted ball picks
- Ideal for use with appetizers, beverages, hors d'oeuvres, and sliders
- Made from quality bamboo - a great eco-friendly alternative to plastic picks

Series	Item	Length	Pack	Weight	Cube
Knot Picks	R798	3½"	10/100	1.4 lbs	0.19
	R803	4"	10/100	1.5 lbs	0.19
	R805	4½"	10/100	1.6 lbs	0.23
	R802	7"	10/100	2.4 lbs	0.28
Paddle Picks	R801	3½"	10/100	2.8 lbs	0.1
	R800	6"	10/100	4.1 lbs	0.15
Display Picks	R799	3½"	10/100	1.6 lbs	0.28
Ball Picks	R797	4¾"	10/100	3.7 lbs	0.27



Item	Round	Square	Kokeshi	Mint	Cello Wrap	Paper Wrap	Pack	Weight	Cube
R820	✓						5/24/800	29.8 lbs	1.07
R820RD	✓						24/800	5.4 lbs	0.22
R820SQ		✓					24/800	7.1 lbs	0.22
R821			✓				24/800	5.7 lbs	0.21
RIW12S	✓				✓		12/1000	4.9 lbs	0.36
RIW15	✓				✓		15/1000	6 lbs	0.43
RM112S	✓		✓	✓	✓		12/1000	4.9 lbs	0.34
RM115	✓		✓	✓	✓		15/1000	6 lbs	0.41
RM125	✓		✓		✓		12/500	3.3 lbs	0.28
RM41M	✓		✓	✓	✓		4/1000	1.7 lbs	0.11



Party Picks

- Festive, colorful and beautifully designed party picks make it easy and fun to identify, enjoy and sip food and beverages
- Club frills picks, cocktail parasols and wood sandwich picks available
- A perfect finishing touch for beverages and appetizers

Item	Description	Pack	Weight	Cube
RP144	Cocktail Parasols	5/10/144	20.5 lbs	1.57
R823	Wood Sandwich Picks	4/12/750	21.6 lbs	1.23
R812W	Club Frill Picks	10/1000	6 lbs	0.44
R811W	Regular Frill Picks	10/1000	4 lbs	0.29

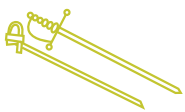

Skewers

Skewers Grilling Tip: We recommend soaking these skewers in water before grilling or cooking to prevent them from burning.

Wooden Skewers

- All-natural wood skewer
- Disposable for easy serving and clean up
- Perfect for grilling, deep-frying, steaming, baking and much more
- Various sizes and diameters available

Length	Item	Diameter	Pack	Weight	Cube
4.5"	R815	3/20"	10/1000	17.7 lbs	0.56
	R814	3/20"	10/1000	20.9 lbs	0.71
5 1/2"	R831	1/4"	5/1000	28.2 lbs	0.99
	R834	3/16"	5/1000	19.6 lbs	0.66
5.9"	R838A	1/8"	10/1500	25.4 lbs	1.08
8 1/2"	R828	3/16"	5/1000	20.9 lbs	1.84
10"	R818	3/20"	3/1000	11.5 lbs	0.41





Bamboo Skewers

- Eco-friendly bamboo skewer
- Disposable for easy serving and clean up
- An eco-friendly alternative to plastic - Compostable & Biodegradable
- Perfect for grilling, deep-frying, steaming, baking, and much more
- Various sizes and diameters available



Flat Bamboo Skewers

Length	Item	Width	Pack	Weight	Cube
7"	BSF7	¼"	6/500	16.5 lbs	0.49
10"	BSF10	¼"	6/500	23.5 lbs	0.68

Round Bamboo Skewers

Length	Item	Diameter	Pack	Weight	Cube
4"	R804	⅜"	12/16/100	21 lbs	0.89
6"	R806	⅜"	12/16/100	31.3 lbs	1.18
8"	R808	⅜"	12/16/100	34.4 lbs	1.70
9"	R835	⅜"	12/16/100	46.7 lbs	1.92
10"	R813	⅝"	12/10/100	40 lbs	1.72
12"	R824	⅝"	12/8/100	39.5 lbs	1.81
18"	R840	5 mm	2/5/100	19.8 lbs	0.58
36"	R841	5 mm	2/5/100	36.4 lbs	1.11

Steak Markers

- Ideal for ensuring that customers receive their specially prepared dish
- Choose from a selection of plastic or wood markers indicated for: Allergies, Well, Medium Well, Medium, Medium Rare, Rare



Series	Item	Style	Color	Pack	Weight	Cube
Plastic	RP146	Allergy	○	5/1000	5.5 lbs	0.19
	RP145A	Rare	●	10/1000	9 lbs	0.31
	RP145A5	Rare	●	5/1000	5.1 lbs	0.17
	RP145B	M-Rare	○	10/1000	9 lbs	0.31
	RP145B5	M-Rare	○	5/1000	5.1 lbs	0.17
	RP145C	Medium	●	10/1000	9 lbs	0.31
	RP145C5	Medium	●	5/1000	5.1 lbs	0.17
	RP145D	M-Well	●	10/1000	9 lbs	0.31
	RP145D5	M-Well	●	5/1000	5.1 lbs	0.16
	RP145E	Well	●	10/1000	9 lbs	0.31
	RP145E5	Well	●	5/1000	5.1 lbs	0.17
	Wood	RP145WA	Rare	○	10/500	10.4 lbs
RP145WB		M-Rare	○	10/500	10.4 lbs	0.42
RP145WC		Medium	○	10/500	10.4 lbs	0.41
RP145WD		M-Well	○	10/500	10.4 lbs	0.43
RP145WE		Well	○	10/500	10.4 lbs	0.42





PROTECTIVE WEAR

AmerCareRoyal offers top quality disposable safety apparel that delivers specialized function and style. From dry particulate and fluid barrier protection to light chemical environments, our apparel has you covered!

Available in a variety of sizes and materials, AmerCareRoyal protective wear is comfortable for all-day wear, and provides outstanding defense against contamination.

Aprons	99
Arm Guards	101
Shoe Covers	102
Lab Coats.....	103
Face Masks	105
Isolation Gowns	106



28461A

Check out
our disposable
glove product
offering on
Page 37

Aprons

From commercial bakeries and kitchens to medical device and industrial facilities, AmerCareRoyal aprons provide excellent wet and dry protective coverage for every need and application. Choose from aprons that give light protection against dirt, dust and grime or splash protection from organic solvents and light chemicals in the non-toxic workplace. Our variety of styles, gauges, materials and packaging are economical, reliable and comfortable.



Polyethylene (PE)

- Cost effective fluid barrier protection
- Strong, reliable and flexible maneuverability
- Impervious to fluids and deliver waterproof protection in non-toxic environments
- Great for use in food service, food processing industries, businesses using paint, degreasing or cleaning agents and more

Size	Item	Gauge	Color	Packed	Pack	Weight	Cube
24" x 42"	DA2442	0.5 mil	○	Dispensing Box	10/100	17.1 lbs	1.18
	DAK2442	1 mil	○	Poly Bag	10/100	14.9 lbs	0.63
	DAK2442B	1 mil	●	Poly Bag	10/100	14.9 lbs	0.63
	24421A	1 mil	○	Dispensing Box	1/1000	17.6 lbs	0.94
28" x 46"	DA2846-4E	4 mil	●	Poly Bag	5/50	26.4 lbs	0.76
	28462A	2 mil	○	Dispensing Box	1/500	31.2 lbs	1.34
	RPA20HW	1.8 mil	○	Dispensing Box	5/100	31.1 lbs	1.25
	RPA20-15	1.5 mil	○	Dispensing Box	5/100	21.5 lbs	1.17
	RPA20	1 mil	○	Dispensing Box	5/100	18.2 lbs	0.93
	DAK2846B	1 mil	●	Poly Bag	10/100	17.8 lbs	0.73
	DAK2846	1 mil	○	Poly Bag	10/100	17.8 lbs	0.73
	DA2846	0.5 mil	○	Dispensing Box	10/100	17.8 lbs	1.47
28461A	1 mil	○	Dispensing Box	1/1000	22.7 lbs	1.09	

Non-Woven Polypropylene

- Lightweight, breathable and offers an economical solution for light duty protection
- Protects against dust, dirt and grime in a non-toxic workplace
- Ideal for use in commercial bakeries, industrial and institutional kitchens, various manufacturers and medical device companies

Size	Item	Color	Packed	Pack	Weight	Cube
28" x 36"	DA2836NW	○	Poly Bag	1/100	4.9 lbs	0.73

Laminated Non-Woven Polypropylene

- Economical solution for light, non-hazardous splash protection
- Non-linting polypropylene impervious to moisture and great tensile strength, delivering consistent protection
- Ideal for use in commercial bakeries, industrial and institutional kitchens, candy manufacturers and medical device companies

Size	Item	Color	Packed	Pack	Weight	Cube
28" x 36"	DA2836NWPL	○	Poly Bag	1/100	5.6 lbs	0.73

PVC with Tie String, Raw Edge

- Non-linting, tear-resistant, waterproof and long-lasting
- Provide excellent wet and dry protective coverage for a variety of needs and applications

Size	Item	Gauge	Color	Packed	Pack	Weight	Cube
35" x 45"	DA3545-6PVCRE	6 mil	●	Poly Bag	1/72	20.3 lbs	0.58
	DA3545-6PVCRW	6 mil	○	Poly Bag	1/72	20.3 lbs	0.58



Protective Wear

Arm Guards

AmerCareRoyal's selection of arm guards help promote safety and cleanliness at any establishment. We offer PVC, poly, polypropylene and Keyguard styles that are ideal for use in poultry and meat packing, food processing, dry food manufacturing, industrial facilities and medical device assembly.

Keyguard Arm Guards

- Provide outstanding durability and protection against dry particulates and fluids in non-toxic environments
- Comfortable micro porous polyolefin fabric is impervious to chemicals and very effective for an array of applications
- Great for use in pharmaceutical manufacturing, medical device assembly and toy industries

Size	Item	Color	Pack	Weight	Cube
18"	RKGAG-100	○	1/100	5.8 lbs	0.69

Polypropylene

- Spun bound polypropylene is a lightweight, breathable fabric providing economical protection
- Best low-cost choice for wear in the non-toxic workplace
- Great for use in bakeries, produce applications and medical device assembly

Size	Item	Color	Pack	Weight	Cube
18"	RPAG-100NWP	○	1/100	3.7 lbs	0.58
	RLPAG-100	○	1/100	4.4 lbs	0.58

Polyethylene - Lightweight

- Impervious to fluids and provides an excellent barrier against water, moisture, organic solvents and light chemicals
- Cost effective for maximum fluid protection
- Ideal for use in meat packing, food processing, dry food manufacturing, candy manufacturing, industrial facilities and medical device assembly

Size	Item	Color	Pack	Weight	Cube
16"	RPAG-500BS	●	20/50	8 lbs	1.02
18"	RPAG-500	○	20/50	8.1 lbs	0.92
	RPAG-500B	●	20/50	8.1 lbs	0.92

PVC

- Strong, flexible and non-linting, offering excellent wet and dry protection
- Great for use in pharmaceutical manufacturing, janitorial cleaning, food processing and medical device assembly

Size	Item	Color	Pack	Weight	Cube
18"	RPVCAG6-144W	○	24/12	20.3 lbs	1
	RPVCAG6-144B	●	24/12	20.3 lbs	1



Shoe Covers

Protect shoes from leaks, spills and harmful substances with AmerCareRoyal's selection of shoe covers. Super sticky, cross-linked PE and polypro styles are available. Shoe covers also come in non-skid designs to ensure user's safety and are ideal for use in hospitals and other institutions to keep shoes clean.

Cross Linked Polyethylene

- Made from a lightweight, waterproof fabric
- Creates an effective barrier against water, moisture, organic solvents and light chemicals

Size	Item	Color	Pack	Weight	Cube
16.5"	RSCCLP-150	○	1/300	5.5 lbs	0.7
LG	RSCCLP-150E	●	1/300	5.5 lbs	0.59
18.5"	RSCCLP-150XL	○	1/300	6.5 lbs	0.9
XL	RSCCLP-150EXL	●	1/300	6.5 lbs	0.9

Super Sticky Polypropylene

- Offers strong, non-skid protection in the workplace
- Spun bond polypropylene has a coated EVA-PE film (with a special treatment) and gives excellent traction on workplace floors
- Perfect for pharmaceutical and healthcare facilities and manufacturing industries

Size	Item	Color	Pack	Weight	Cube
16.5"	RSCSS-150W	○	1/300	6.6 lbs	0.81
	RSCSS-150E	●	1/300	6.6 lbs	0.81
18.5"	RSCSS-150WXL	○	1/300	9.6 lbs	1.11
	RSCSS-150EXL	●	1/300	9.6 lbs	1.11

Polypropylene Shoe Covers

- Quality barrier protection from dry particulate
- Breathable fabric is hand crafted with a non-skid sole and offers economical protection for use in the non-toxic workplace
- Ideal for use in healthcare and pharmaceutical facilities, electronic device assembly, commercial and institutional foodservice, cable TV repair and many more applications

Size	Item	Color	Pack	Weight	Cube
L	RSC150W-WNS	○ with White Tred	1/300	4.5 lbs	0.66
	RSC150W-NS	○ with Blue Tred	1/300	4.6 lbs	0.66
	RSC150BK-NS	●	1/300	4.6 lbs	0.66
	RSC150-NS	● with White Tred	1/300	4.6 lbs	0.66
XL	RSC150-NSXL	● with White Tred	1/300	6 lbs	1.06





Protective Wear



LCO-ENW-BM

Lab Coats

From lightweight visitor's coat to complete coverage to protect against chemical exposure, AmerCareRoyal offers a wide selection of top-quality materials for every application. Each style is pocket free and features elastic wrists, snap front and a single collar to ensure ease of movement. Select from a wide variety of styles, gauges and materials that are economical, reliable, comfortable and meet IEST.org standards and practices.

Keyguard Lab Coats

- Provide outstanding durability and protection against dry particulate and fluids in non-toxic environments
- Comfortable micro porous polyolefin fabric is impervious to chemicals, effective in a variety of applications
- Ideal choice for pharmaceutical, medical device assembly, electronic device assembly, research and clinical facilities

Size	Item	Color	Pack	Weight	Cube
S	LCO-EKG-S	○	1/30	8.3 lbs	0.99
M	LCO-EKG-M	○	1/30	8.3 lbs	0.99
L	LCO-EKG-L	○	1/30	8.4 lbs	0.99
XL	LCO-EKG-XL	○	1/30	8.5 lbs	0.99
2X	LCO-EKG-2X	○	1/30	9 lbs	0.99
3X	LCO-EKG-3X	○	1/30	9.5 lbs	0.99
4X	LCO-EKG-4X	○	1/30	10.2 lbs	0.99
5X	LCO-EKG-5X	○	1/30	10.3 lbs	0.99



Polypropylene HD Lab Coats

- Made from 40-gram heavy duty polypropylene
- Flexible, strong and deliver outstanding particulate barrier protection in non-toxic environments with lasting comfort and a secure fit
- Ideal for use in food processing facilities; pharmaceutical manufacturers; and any industry that requires a strong barrier protection

Size	Item	Color	Pack	Weight	Cube
S	LCO-ENWHD-S	○	1/30	5.6 lbs	1.08
M	LCO-ENWHD-M	○	1/30	5.7 lbs	1.08
L	LCO-ENWHD-L	○	1/30	6.1 lbs	1.08
XL	LCO-ENWHD-XL	○	1/30	6.2 lbs	1.08
2X	LCO-ENWHD-2X	○	1/30	6.3 lbs	1.08
3X	LCO-ENWHD-3X	○	1/30	6.4 lbs	1.08
4X	LCO-ENWHD-4X	○	1/30	6.6 lbs	1.08
5X	LCO-ENWHD-5X	○	1/30	7 lbs	1.08

SMS Lab Coats

- Made from a unique tri-laminate polypropylene fabric that offers high tensile strength and toughness, but also soft and drapable
- SMS lab coats provide an excellent fluid and particulate barrier in non-toxic environments without sacrificing mobility and comfort
- Ideally suited for pharmaceutical and medical device assembly, pharmaceutical and dental labs and general manufacturing

Size	Item	Color	Pack	Weight	Cube
S	LCO-ESMS-S	○	1/30	6.3 lbs	1.25
M	LCO-ESMS-M	○	1/30	6.3 lbs	1.25
L	LCO-ESMS-L	○	1/30	6.4 lbs	1.25
XL	LCO-ESMS-XL	○	1/30	6.8 lbs	1.25
2X	LCO-ESMS-2X	○	1/30	6.8 lbs	1.25
3X	LCO-ESMS-3X	○	1/30	6.8 lbs	1.25
4X	LCO-ESMS-4X	○	1/30	6.9 lbs	1.25
5X	LCO-ESMS-5X	○	1/30	7 lbs	1.25

Polypropylene Lab Coats

- Made from lightweight and breathable polypropylene fabric that is strong, durable and comfortable
- Perfect economical choice for non-toxic environments
- Special features like elastic wrists, snap front and single collar offer ease of movement and a secure comfort fit
- Best for use in bakeries, dental labs, electronic device assembly and lab settings

Size	Item	Color	Pack	Weight	Cube
S	LCO-ENW-S	○	1/30	4.3 lbs	0.83
	LCO-ENW-BS	●	1/30	4.3 lbs	0.83
M	LCO-ENW-M	○	1/30	4.3 lbs	0.83
	LCO-ENW-BM	●	1/30	4.3 lbs	0.83
L	LCO-ENW-L	○	1/30	4.9 lbs	0.83
	LCO-ENW-BL	●	1/30	4.9 lbs	0.84
XL	LCO-ENW-XL	○	1/30	5 lbs	0.83
	LCO-ENW-BXL	●	1/30	5 lbs	0.83
2X	LCO-ENW-2X	○	1/30	5.1 lbs	0.84
	LCO-ENW-B2X	●	1/30	5.1 lbs	0.83
3X	LCO-ENW-3X	○	1/30	5.3 lbs	0.83
	LCO-ENW-B3X	●	1/30	5.1 lbs	0.83
4X	LCO-ENW-4X	○	1/30	5.9 lbs	0.83
	LCO-ENW-B4X	●	1/30	5.3 lbs	0.83
5X	LCO-ENW-5X	○	1/30	6.2 lbs	0.83
	LCO-ENW-B5X	●	1/30	6.2 lbs	0.83



LCO-EKG-L



LCO-ESMS-XL



Protective Wear



RPFM-ELE

Face Masks

If you have staff working in dental, medical, hospital, laboratory or food processing or similar environments, AmerCareRoyal's hoods and face masks are a good choice to maintain sanitary or food-safe conditions.

Polypropylene Non-woven Face Mask with Ear Loop

- Soft and form-fitting, latex-free
- Triple layer mask comes with comfortable ear loops and provides complete protection
- Rated for PFE (particulate filtration efficiency) at 98% or higher ASTM Standard F2101
- Perfect for use in hospital and healthcare facilities, pharmaceutical manufacturing, food processing and industrial settings

Lightweight Polypropylene Hood with Elastic Face Closure

- One-piece, latex-free with elastic face closure delivers strength and toughness, yet is soft and comfortable for all day wear
- Poly-coated fabric provides maximum particulate protection from dirt and grime and is an ideal choice in non-hazardous environments
- One size fits all

Item	Description	Color	Pack	Weight	Cube
RPPH100	Polypropylene Hood with Elastic Face Enclosure	○	10/100	8.3 lbs	1.22
RPFM-ELE-W	Non-Woven Face Mask with Ear Loop	○	1/500	4.1 lbs	0.7
RPFM-ELE	Non-Woven Face Mask with Ear Loop	●	1/500	4.1 lbs	0.7





ISOPE-E



ISONW-Y



Isolation Gowns

AmerCareRoyal's disposable isolation gowns are an ideal barrier against dry or fluid materials in medical, hospital, research and development, food processing or other environments. Our isolation gowns are available in both polyethylene and polypropylene.

Polyethylene with Thumb Loops

- Provide optimum splash protection that is impervious to fluids
- Material resembles plastic and does not have breathability, making it an ideal barrier that isolates bacteria and dust
- Thumb loops minimize slippage for ease of application

Polypropylene

- Great for dry applications
- Low cost, 100% non-woven polypropylene is lightweight, breathable and durable - making for ideal use in non-toxic environments
- Perfect for lab operators in research and development facilities

Size	Item	Color	Material	Pack	Weight	Cube
One Size Fits All	ISONWP-W	○	Polypropylene + Polyethylene	1/50	7.7 lbs	1.26
	ISONW-Y	●	Polypropylene	1/50	8.1 lbs	1.02
	ISONW-W	○	Polypropylene	1/50	8.1 lbs	1.02
	ISONW-E	●	Polypropylene	1/50	8.1 lbs	1.02
47"	ISOPE-W	○	Polyethylene	1/100	12.1 lbs	0.96
	ISOPE-E	●	Polyethylene	1/100	12.1 lbs	0.96
55"	ISOPE-EXL	●	Polyethylene	1/100	12.6 lbs	0.96





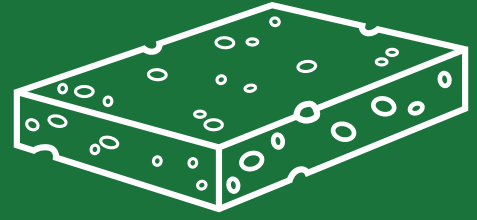

SCOURING PADS & SPONGES

Choose from scouring pads and scrubbers for light, medium and heavy-duty cleaning applications. Each affordable, non-chemical based cleaning product deliver consist powerful cleaning performances when and where you need it most.

Scouring Pads	109
Sponge & Scrubber Combos	111
Soap Pads	112
Stainless Steel Metal Sponges	112
Utility Pads and Holder	112
Grill Cleaning	113

Scouring Pads & Sponges

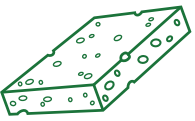

Scouring Pads Usage Chart

Item	Light Duty	Medium Duty	Heavy Duty	Utility	Metal & Soap
Baseboards				✓	
Baked On Cheese & Sauces			✓		✓
Equipment, Cooking, Maintenance & Kitchen	✓	✓	✓		✓
Countertops/Laminates	✓				
Floors	✓	✓	✓	✓	✓
General In-Sink Applications	✓	✓			✓
Plastics, Glass & Mirrors	✓				
Granite	✓				
Griddles, Fryers & Hot Surfaces	✓	✓	✓	✓	✓
Non-Stick Surfaces	✓				
Pots & Pans	✓	✓	✓		✓
Sinks, Tubs & Showers	✓	✓	✓		✓
Stainless Steel Surfaces	✓				
Vinyl	✓				
Wood	✓				

Scouring Pads

Light Duty Scouring Pads

- Gentle effective cleaning for most surfaces in kitchens and institutions
- Fights dirt, grime and grease with soft, non-woven fibers and mild abrasives
- Gently clean without scratching or dulling finishes
- Great for porcelain, stainless steel, chrome, copper, fine china, ceramic and Teflon® surfaces



S903

- Mainly used to clean surfaces that require gentle action
- Great for stainless steel, chrome, copper, fine china, porcelain, ceramic and Teflon® surfaces
- Will not scratch or dull most surfaces



S490

- Soft, non-woven fibers and mild abrasives gently clean most surfaces
- Great for stainless steel, chrome, copper, fine china, porcelain, ceramic, and Teflon® surfaces

Item	Dimensions	Color	Pack	Weight	Cube
S903	3½" X 5"	○	1/40	1.2 lbs	0.44
S490	6" x 9" x ¼"	○	6/10	2.3 lbs	0.67



Medium Duty Scouring Pads

- Synthetic scouring pads are ideal for most general cleaning jobs
- Made with non-woven fibers and abrasives that enhance strength and effectiveness
- Flexible, full sized scouring pads are ideal for most in sink applications and everyday scouring jobs

Item	Dimensions	Color	Pack	Weight	Cube
S965	3½" x 5" x ¾"	●	1/40	0.9 lbs	0.20
S960/20	6" x 9" x ¼"	●	1/20	1.1 lbs	0.22
S980	6" x 9" x ¼"	●	1/60	2.9 lbs	0.65
S960	6" x 9" x ¼"	●	6/10	3.0 lbs	0.66
REN960/20	6" X 9"	●	1/20	1.3 lbs	0.33

Heavy Duty Scouring Pads

- Heavy duty scrubbing pads make fast work of heavy-duty cleaning jobs in kitchens and building maintenance applications
- Effective, versatile pads are made of tough, non-woven fibers and abrasives
- Ideal for baked on food on grills, frying pans, baking utensils and much more

Item	Premium	Dimensions	Color	Pack	Weight	Cube
S880/20	✓	3½" x 5" x ¾"	●	1/20	1 lbs	0.18
S880-610	✓	3½" x 5" x ¾"	●	6/10	3 lbs	0.63
S880		3½" x 5" x ¾"	●	3/12	1.7 lbs	0.41
S860/20	✓	6" x 9" x ¾"	●	1/20	1.4 lbs	0.30
S860		6" x 9" x ¾"	●	6/10	4.2 lbs	0.82

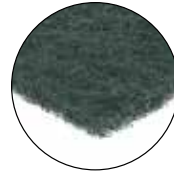

S965

- Thick general-purpose cleaning pad made of tough fibers and abrasives
- Excellent for cleaning and scouring kettles, pots and countertops



S960 & S980

- Original synthetic scouring pad is ideal for most cleaning jobs
- Perfect for walls, railings, floors, desks, coffee makers, broilers, stairways and countertops



S860/20

- Tough fibers and abrasives make fast work of heavy duty cleaning jobs
- Remove baked on food from grills, pans and baking utensils
- Great for removing scuff marks on floor



SS880/20

- Non-woven fibers and abrasives will not rust, an alternative to wool and metal scrubbers
- Most aggressive pad available
- Kitchen equipment, heavily encrusted pots and pans, grimy maintenance equipment



S460

- Strong nylon web construction contains hard working abrasives for added cleaning power
- For use on grills to remove burnt on food and grease



S860

- Effective, versatile pad made of non-woven fibers and abrasives
- Flexible scouring pad allows for easy removal of baked on foods in difficult corners and hard to reach places



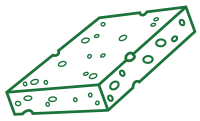

Scouring Pads & Sponges



Combos

S630C/20

- Light duty cleaning pad/cellulose sponge gently cleans most surfaces
- Porcelain, china, ceramic tile, plastics, stoves, non-stick cookware and painted surfaces

- Dual action, nylon pad/cellulose sponge delivers powerful, effective cleaning
- Walls, tables, fixtures, countertops, floors, utensils and stainless-steel stove hoods



S610

- Synthetic scouring sponge with extra strength abrasive added to one side
- For sinks, walls or cleaning utensils



S740C/20



Item	Description	Dimensions	Color	Pack	Weight	Cube
S630C/20	Premium Light Duty Scrubbing Pad/Sponge	3¾" x 6½" x ¾"	○	1/20	2.1 lbs	0.32
S610	Abrasive Pad & Synthetic Sponge	6" x 9" x ¼"	●	1/48	2 lbs	0.41
S740C/20	Premium Scouring Pad/Sponge	3¾" x 6½" x ¾"	●	1/20	2.1 lbs	0.32
S740	Scouring Pad/Sponge	3½" x 6½"	●	8/6	1.9 lbs	0.60



Metal & Soap Sponges

- Regular, heavy-duty or scratch-free sponges perfect for use in the kitchen, the bathroom, prep areas and tabletops
- Nylon, synthetic, stainless steel or plastic mesh options in an array of shapes and sizes

S730 & S775

- High-grade stainless steel with four sided strands will not rust or splinter
- Removed baked on food from pots, baking dishes, ovens and grills



Size	Item	Boxed	Gram Weight	Pack	Weight	Cube
Regular	S730BX	✓	35	12/12/1	15.9 lbs	1.67
	S730/6		35	6/12/1	6.6 lbs	0.63
	S730		35	12/12/1	13.2 lbs	1.26
Large	S775BX	✓	50	12/12/1	22 lbs	2.14
	S775/6		50	6/12/1	9.3 lbs	0.79
	S775		50	12/12/1	18.1 lbs	1.59

Soap Pads

S1012

- Made of fine steel wool container effective grease cutting detergents
- Pots and pans, cooking utensils, grimy maintenance equipment and tough baked-on food particles



Item	Dimensions	Color	Pack	Weight	Cube
S1012	3½" x 3½" x 1"	●	12/10	8.2	0.75

Wipe Out Sponge

- Uses water alone - no harsh chemicals
- Multi-surface cleaning - use on walls, floors, doors, baseboards, kitchen appliances, tiles and more



Item	Dimensions	Color	Pack	Weight	Cube
S724	4⅝" X 2½" X 1"	○	1/24	0.6 lbs	0.43

Utility Pads

RP8543

- Fine, non-abrasive and cleans delicate surfaces without scratching
- Perfect for sinks, ceramic tiles, windows, tubs, toilets and many other delicate places

RP8542

- Strong enough for tough cleaning tasks without stripping or damaging the surface
- Ideal for scuff marks on floor edges, baseboards and swimming pool walls

RP8541

- Cleans and strips floor edges by removing old finish and wax buildup
- Great in hallways, stairs and around stoves and fryers

Item	Description	Dimensions	Color	Pack	Weight	Cube
RP8543	Light Duty	10" x 4½"	○	4/5	2.4 lbs	0.69
RP8542	Medium Duty	10" x 4½"	●	4/5	5 lbs	0.69
RP8541	Heavy Duty	10" x 4½"	●	4/5	2.4 lbs	0.69



Utility Pad Holder

- Unique hook-and-loop bottom locks pads on, eliminating slipping without the use of adhesives or fasteners
- Screw-N-Lock Holder neck rotates 360 degrees allowing access to tight spots
- Great for tough jobs, such as removing finish and wax from baseboards, floor edges and stairs

Item	Description	Pack	Weight	Cube
RPDB-SH	Screw-N-Lock Pad Holder Universal	1/12	5 lbs	0.6



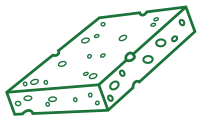

Scouring Pads & Sponges

Grill Cleaning

Keep the grills in your restaurant, food truck or catering establishment shining and like new. Dirty grills clean up quickly with AmerCareRoyal grill cleaning supplies. With a full line of products available, we have everything you need to keep your grill equipment clean and ready to use.

Grill Brick

- Quickly remove residue and caked on carbon from hot grills
- Foam glass material provides deep cleaning without chemicals, individually wrapped in polyethylene film
- Great for cleaning badly charred pots, pans and utensils
- Designed to be used on dull stainless-steel griddles
- Not recommended for use on shiny stainless-steel tables or equipment



Item	Color	Pack	Weight	Cube
RGB49	●	1/12	7 lbs	0.87

Grill Pads

- Remove burned food and grease easily
- Great for cleaning grill surfaces, kitchen pots and pans, cookie sheets and other utensils that need a deep cleaning
- Strong nylon web construction contains hard working abrasives for added cleaning power



Item	Dimensions	Color	Pack	Weight	Cube
S460/20	4" x 6" x 1/4"	●	1/20	1 lbs	0.19
S460	4" x 6" x 1/4"	●	6/10	2.6 lbs	0.63

Grill Screens

- Abrasive, open mesh polishing grill screens are heat resistant and ideal for use on hot grills to remove food particles and restore the original shine
- Rayon treated material resists clogging while removing food particles during cleaning
- Best used with a griddle cleaning pad along with an optional holder on hot grill surfaces



Item	Dimensions	Pack	Weight	Cube
GS508	9" x 5 1/2"	50/8	7.3 lbs	0.27
GS4100	4" x 5"	4/100	7 lbs	0.24
GS2025	4" x 5"	20/25	8.6 lbs	0.32
GS1020	4" x 5 1/2"	10/20	3.8 lbs	0.15

HOLDERS

- Reduce the danger of burns while cleaning hot grills in commercial kitchens
- Great for other cleaning applications with hand size scouring pads
- Use with AmerCareRoyal's griddle screen and grill cleaning pads to clean and polish grills



Item	Description	Pack	Weight	Cube
GS483	Grill Screen & Pad Holder	1/12	2.4 lbs	0.33

Kits

- Easily remove dirt and grease from grills
- Convenient and economical

Item	Description	Pack	Weight	Cube
GS484	One metal base holder, One S460 Pad, One Grill Screen	1/1	0.7 lbs	0.05
GCKIT	One GS483 holder, Ten S460 pads, Twenty Grill Screens	1/1	12.2 lbs	0.30



Scouring Pads & Sponges





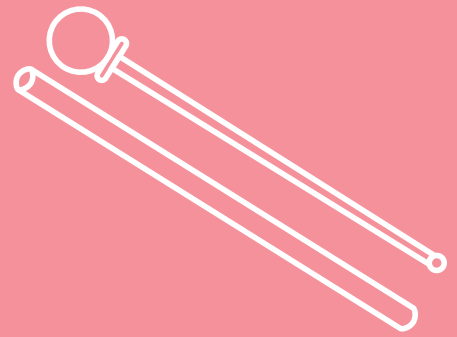

STRAWS & STIRRERS

Great for consuming cold beverages on a hot summer day, or stirring your favorite coffee, AmerCareRoyal straws meet a wide range of customer needs. Choose from a selection of stirrers, coffee lid plug sticks, coffee stir sticks, sip straws, as well as a variety of plastic and eco-friendly paper straws.

Giant Straws	118
Jumbo Straws	119
Sip Straws	120
Paper Straws	121
PLA Straws	121
Stir Straws	122
Stirrers	122
Stix To Go	122

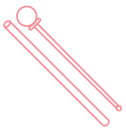



On this page: STNGT1970704

Straws & Stirrers

Perfect for consuming cold beverages on a hot summer day or stirring coffee, AmerCareRoyal's straws meet a wide range of customer needs. Choose from a selection of straws, stirrers, coffee stir and plug sticks. Whether wrapped or unwrapped, our straws are a great addition to any bar, restaurant or catering service looking for disposable straws.



Straw Diameter Sizing Chart	GIANT	JUMBO	SIP
			
	7.37mm	6.35mm	5.60mm
			2.85mm

Giant Poly Straws

- Available in unwrapped or wrapped for extra sanitary protection
- Perfect for thicker beverages such as milkshakes and smoothies
- Available in a variety of colors

Item	Length (in)	Color	Heavyweight	Paper Wrap	Poly Wrap	Pack	Weight	Cube
STNGT1400502	5¾"	●	✓			24/300	9.1 lbs	2.12
STNGT1400503	5¾"	●		✓		24/500	26.1 lbs	5.97
STNGT1970703	7¾"	⊗				24/300	11.0 lbs	2.97
STNGT1970704	7¾"	⊗		✓		24/300	16.8 lbs	4.00
STNGT1970705	7¾"	⊗		✓		24/300	16.7 lbs	0.90
STNGT1970708	7¾"	●	✓	✓		24/300	18.9 lbs	3.98
STNGT1970721	7¾"	●	✓			10/150	3.5 lbs	0.68
STNGT1970722	7¾"	●	✓	✓		24/300	18.7 lbs	3.99
STNSJ1970701	7¾"	●				24/300	12.0 lbs	2.24
STNSJ1970704	7¾"	●		✓		24/300	23.1 lbs	3.41
STNSJ1970705	7¾"	⊗	✓			24/400	18.0 lbs	3.97
STNSJ1970710	7¾"	●	✓		✓	24/500	27.2 lbs	5.84
STNGT2160819	8½"	●	✓	✓		4/300	3.6 lbs	0.77
STNGT2290904	9"	●		✓		24/300	18.9 lbs	4.68
STNGT2290905	9"	●				24/300	17.0 lbs	3.50
STNGT2290906	9"	●		✓		4/300	3.4 lbs	0.86
STNGT2290909	9"	●			✓	24/300	20.9 lbs	4.71
STNGT2290919	9"	●	✓	✓		10/300	8.5 lbs	1.87
STNGT2290926	9"	●		?	?	4/300	4.0 lbs	0.80
STSGT2601007	10"	●			✓	12/300	14.5 lbs	3.13
STNGT2601001	10¼"	●		✓		4/300	6.0 lbs	0.89
STNGT2601002	10¼"	●		✓		4/300	4.5 lbs	0.92
STNGT2601003	10¼"	⊗		✓		4/300	4.3 lbs	0.90
STNGT2601008	10¼"	●		✓		4/300	4.3 lbs	0.91
STNSJ2601012	10¼"	●	✓		✓	12/500	19.7 lbs	3.78
STNGT3051203	12"	●		✓		4/500	8.1 lbs	1.77



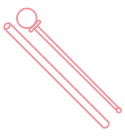

Stirrers & Straws

Jumbo Poly Straws

- Available in unwrapped or wrapped for extra sanitary protection
- Perfect for just about any hot or cold beverage
- Available in a variety of colors



Have you checked out our Disposable Cup line? **Page 23**

Item	Length (in)	Color	Heavyweight	Paper Wrap	Poly Wrap	Pack	Weight	Cube
STNJM1460501	5¾"	●				50/250	14.4 lbs	2.57
STNJM1460502	5¾"	●		✓		24/500	17.0 lbs	3.15
STNJM1460503	5¾"	⊗				50/250	15.2 lbs	2.40
STNJM1460504	5¾"	◐		✓		24/500	18.0 lbs	3.16
STNJM1520602	6"	●				24/500	14.5 lbs	2.68
STNJM1970703	7¾"	⊗		?	?	24/500	13.0 lbs	3.96
STNJM1970704	7¾"	◐		✓		24/500	19.4 lbs	3.97
STNJM1970711	7¾"	⊗				24/500	15.4 lbs	3.00
STNJM1970712	7¾"	●				24/500	15.0 lbs	2.96
STNJM1970713	7¾"	◐				24/500	15.5 lbs	3.20
STNJM1970714	7¾"	●				10/500	6.7 lbs	1.26
STNJM1970720	7¾"	●		✓		24/500	20.0 lbs	4.00
STNJM1970721	7¾"	⊗		✓		4/500	3.8 lbs	0.72
STNJM1970725	7¾"	⊗			✓	10/500	8.6 lbs	1.91
STNJM1970733	7¾"	●		✓		10/500	8.6 lbs	1.82
STNJM1970750	7¾"	●			✓	24/500	19.7 lbs	4.18
STNJM1970763	7¾"	●●●●			✓	4/500	0.8 lbs	0.68
STNJM1970774	7¾"	●		✓		4/500	3.3 lbs	0.71
STNJM2290901	9"	⊗		✓		24/500	22.5 lbs	4.85
STNJM2290903	9"	⊗		✓		4/500	4.8 lbs	0.86
STNJM2410904	9½"	●		✓		4/500	3.9 lbs	0.83
STNJM2601003	10¼"	⊗		✓		4/500	6.0 lbs	0.93
STNJM2601004	10¼"	●		✓		4/500	5.7 lbs	0.89
STNJM2601005	10¼"	●		✓		4/500	6.2 lbs	0.89
STNJM2601006	10¼"	◐		✓		4/500	6.0 lbs	0.93
STNJM2601007	10¼"	⊗				4/500	4.8 lbs	0.72
STNJM2601008	10¼"	●				4/500	4.8 lbs	0.72
STNJM2601011	10¼"	⊗			✓	4/500	5.9 lbs	0.87
STNJM2601015	10¼"	⊗		✓		12/500	17.7 lbs	2.77
STNJM2601024	10¼"	◐		✓		4/500	5.9 lbs	0.90
STNJM3051206	12"	●		✓		4/300	4.0 lbs	0.82
STNJM6092401	24"	●				4/500	9.8 lbs	1.58



Flex Straw
Paper Wrapped
Polypropylene

Item	Length (in)	Color	Pack	Weight	Cube
STXJM1970710	7¾"	☉	12/400	10.5 lbs	2.15

Sip Straws

- Simple but elegant and great for just about any kind of beverage
- Perfect for coffees and cocktails

Item	Length (in)	Color	Paper Wrap	Poly Wrap	Pack	Weight	Cube
S1525	5"	☉			10/1000	5.1 lbs	0.55
S1525A	5"	●			10/1000	4.1 lbs	0.57
S1525BK	5"	●			10/1000	5.1 lbs	0.55
STNST1270501	5"	●			10/1000	5.1 lbs	0.54
STNST1270503	5"	☉			10/1000	5.4 lbs	0.59
STNST1400501	5½"	●			10/1000	6.5 lbs	0.60
STNSL1460501	5¾"	○	✓		24/500	15.2 lbs	2.08
STNSL1780704	7"	●	✓		10/500	7.7 lbs	1.29
STNST1780700	7"	☉			10/1000	7.6 lbs	0.94
STNST1780701	7"	●		✓	10/1000	15.4 lbs	2.08
STNST1780705	7"	●			10/1000	6.9 lbs	0.96
S1525A7	7½"	●			10/1000	7.8 lbs	0.78
S1525BK7	7½"	●			10/1000	9.1 lbs	0.80



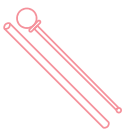

Stirrers & Straws



Paper Straws

- A great option for any eco-conscious foodservice location
- Function just like plastic
- Perfect for eco-friendly restaurants that operate in plastic ban municipalities

Style	Item	Length (in)	Color	Paper Wrap	Pack	Weight	Cube
Cocktail	STNSLP1460501	5¾"	●		8/500	9.0 lbs	0.97
	STNJMP1970701	7¾"	○		12/500	17.9 lbs	1.75
	STNJMP1970702	7¾"	○	✓	12/500	20.9 lbs	2.63
Jumbo	STNJMP1970703	7¾"	○		8/500	11.7 lbs	1.28
	STNJMP1970704	7¾"	●		8/500	11.7 lbs	1.28
	STNJMP1970705	7¾"	●		8/500	11.7 lbs	1.28
	STNJMP1970706	7¾"	●		8/500	11.7 lbs	1.28
	STNJMP1970707	7¾"	●		8/500	11.7 lbs	1.28
	STNGTP1970701	7¾"	●		8/300	7.9 lbs	0.93
	STNGTP2601001	10¼"	○		12/300	18.3 lbs	2.60
Giant	STNGTP2601002	10¼"	○	✓	12/300	21.4 lbs	3.66
	STNGTP2601003	10¼"	○		8/300	8.4 lbs	1.20

PLA Straws

- Eco-friendly PLA straws are made from corn-based plastic
- Meet ASTM D6400 for compostability
- Paper wrapped and unwrapped styles available

Style	Item	Length (in)	Color	Paper Wrap	Pack	Weight	Cube
Jumbo	STNJML1970701	7¾"	⊗		12/500	15.2 lbs	1.89
	STNJML1970702	7¾"	⊗	✓	12/500	15.2 lbs	2.37
Giant	STNGTL2601001	10¼"	⊗		12/300	14.3 lbs	1.98
	STNGTL2601002	10¼"	⊗	✓	12/300	14.3 lbs	2.64



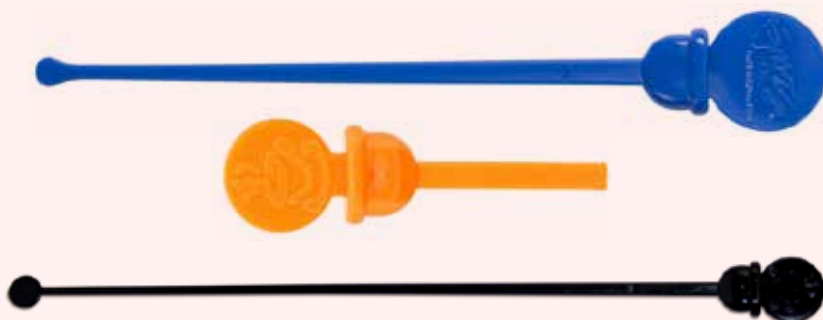

Style	Item	Length	Color	Pack	Weight	Cube
Circle Beverage Plug	CPLUG-A	2"	●	5/400	5.2 lbs	0.25
	CPLUG-BK	2"	●	5/400	5.2 lbs	0.25
	CPLUG-C	2"	●	5/400	5.2 lbs	0.23
	CPLUG-O	2"	●	5/400	5.2 lbs	0.25
	CPLUG-V	2"	●●●●●	5/400	5.2 lbs	0.25
	CPLUG-W	2"	○	5/400	5.2 lbs	0.25
StirStix	STIRSTIX-A	4¾"	●	10/200	5.5 lbs	0.36
	STIRSTIX-BK	4¾"	●	10/200	5.5 lbs	0.37
	STIRSTIX-E	4¾"	●	10/200	5.5 lbs	0.36
Stir N Plug	STRNPLUG-BK	7½"	●	10/200	8.0 lbs	1.03
	STRNPLUG-O	7½"	●	10/200	8.0 lbs	1.03
	STRNPLUG-W	7½"	○	10/200	8.0 lbs	1.03

CPLUG Beverage Plug

- Snaps firmly into the sipping hole of a disposable coffee lid
- Available in polystyrene

StirStix

- Stir your beverage and secure the plug into the lid
- Available in polypropylene

Stir N Plug

- Stir your beverage, snap the stirrer and insert the plug into the lid
- Available in polystyrene

Stir Straws

- A wide range of stir sticks available— from classic wooden disposables, plastic ball point stirrers to eco-friendly bamboo foodservice disposables
- Great for all drinks
- Perfect for break rooms, coffee bars, or tea and coffee stations

	Item	Length	Color	Paper Wrap	Pack	Weight	Cube
Bamboo	R810B	5½"	●		10/1000	13.2 lbs	0.43
	R825B	7"	●		10/500	7.6 lbs	0.31
	R825BW	7"	●	✓	10/500	15.4 lbs	1.10
Plastic	RP150-6BK	6"	●		5/500	12.8 lbs	0.54
	RP150-6C	6"	●		5/500	12.8 lbs	0.54
Wood	R810	5½"	●		10/1000	7.7 lbs	0.35
	WS7	7"	●		10/1000	18.2 lbs	0.82
	R825	7¾"	●		10/500	9.3 lbs	0.44
	R825W	7¾"	●	✓	10/500	9.3 lbs	0.44





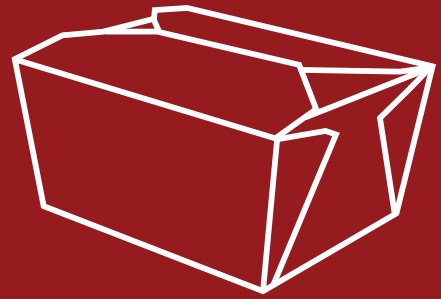

TAKE OUT PACKAGING

AmerCareRoyal's reliable take out packaging is designed to meet all your carryout needs. Our selection of take out and carry out boxes, containers and bags have your food restaurant, food truck or food service operation covered. Choose from a selection of BPA-free polypropylene recyclable, BPI-certified, PLA-lined compostable, kraft or colored paper options in all shapes and sizes.

Paper Food Containers	125
Compostable Hot & Cold Food Containers.....	127
Folded Take Out Boxes.....	128
Microwaveable To-Go Containers	129
Deli Containers	131
Hinged Lid Containers.....	132
Portion Cups	133
Corrugated Take Out & Catering Boxes	135
Eco-Friendly Tableware	137
Take Out Bags.....	139



Take Out Packaging

Check out our napkins on **Page 83** & our cutlery on **Page 3!**



PFC8W, PFC12W, PFC12N with CL812N, PFC16N and PFC32W

Paper Food Containers

AmerCareRoyal's Paper Food Containers offer restaurants, hotels, cafeterias and other food service locations reliable and portable food serving options for their customers offered in bulk or combination sets. Perfect for serving anything from soups, stews and pasta to fresh fruit, ice cream or frozen yogurt. Combination options available.

Containers:

- PE coated inside (white containers are also coated on the outside)
- Available in Kraft or white
- Leak- and grease-resistant
- Size options: 8oz, 12oz, 16oz, 32oz

Lids:

- Recyclable polypropylene, Kraft or white paper options
- Vented lids
- Three sizes available
- Leak- and grease-resistant



Paper Food Container Bulk Packaging

Size	Item	Color	Pack	Weight	Cube
8oz	PFC8N	●	20/25	11.9 lbs	2.01
	PFC8W	○	20/25	12.5 lbs	2.10
12oz	PFC12N	●	20/25	14.5 lbs	2.22
	PFC12W	○	20/25	15.2 lbs	2.22
16oz	PFC16N	●	20/25	17.4 lbs	2.66
	PFC16W	○	20/25	17.9 lbs	2.66
32oz	PFC32N	●	20/25	26.9 lbs	4.53
	PFC32W	○	20/25	27.3 lbs	4.56

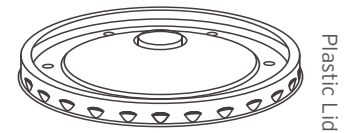
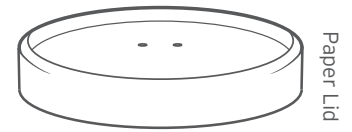

Vented Food Container Lids

Size	Item	Color	Material	Pack	Weight	Cube
8oz-12oz	CL812N	●	Paper	20/25	11.7 lbs	2.40
	CL812PP	⊗	Plastic	20/25	5.1 lbs	1.59
	CL812W	○	Paper	20/25	10.8 lbs	2.40
16oz	CL16N	●	Paper	20/25	12.1 lbs	3.33
	CL16PP	⊗	Plastic	20/25	5.5 lbs	1.77
	CL16W	○	Paper	20/25	13.0 lbs	2.83
32oz	CL32N	●	Paper	20/25	16.1 lbs	3.96
	CL32PP	⊗	Plastic	20/25	7.9 lbs	2.51
	CL32W	○	Paper	20/25	17.0 lbs	3.96

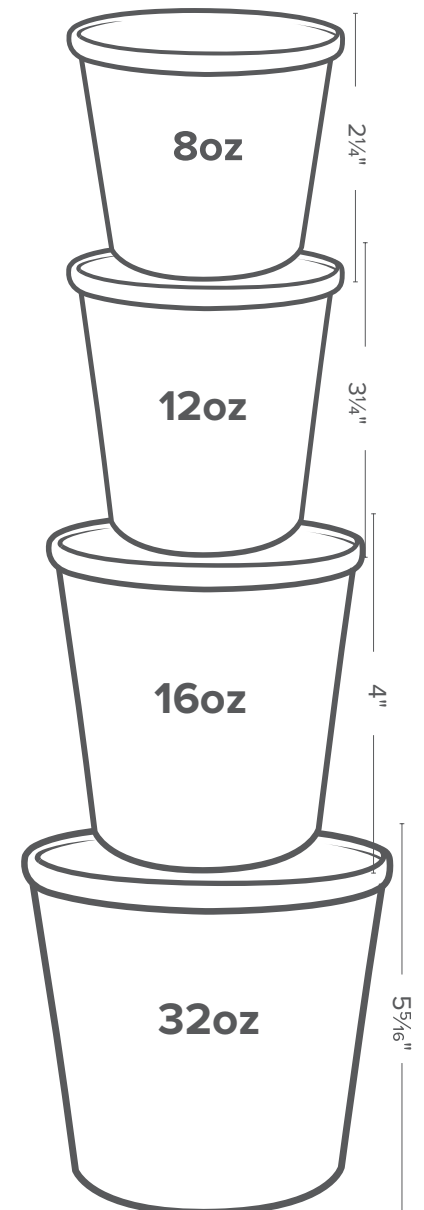

Food Container/Lid Combo Packaging*

Size	Item	Color	Pack	Weight	Cube
8oz	PFC8NCOM	●	1/250	11.2 lbs	2.10
	PFC8WCOM	○	1/250	11.2 lbs	1.97
12oz	PFC12NCOM	●	1/250	13.6 lbs	2.25
	PFC12WCOM	○	1/250	13.6 lbs	2.25
16oz	PFC16NCOM	●	1/250	15.0 lbs	2.56
	PFC16WCOM	○	1/250	15.0 lbs	2.57
32oz	PFC32NCOM	●	1/250	21.6 lbs	3.76
	PFC32WCOM	○	1/250	21.6 lbs	3.76

* Combo packaging only available with matching paper lid

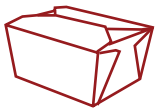

Take Out Packaging



FC-8, FC-12, FC-16, CFCL-8 and CFCL-1232

Compostable Hot and Cold Food Containers



PLA-Lined Paper Containers and CPLA Lids

- PLA-lined to keep food fresh
- Food containers feature a patterned design
- Can be topped with compostable CPLA lids
- Fully compostable

Item	Size	Pack	Weight	Cube
FC-8*	8oz	2/100	18.3 lbs	1.32
FC-12*	12oz	2/100	18.3 lbs	1.28
FC-16*	16oz	2/80	13.8 lbs	1.05
FC-32*	32oz	2/80	13.8 lbs	1.05
CFCL-8*	8oz Lid	4/125	24.6 lbs	1.70
CFCL-1232*	12oz-32oz Lid	2/100	16.9 lbs	1.24



PrimeWare Sustainable Product



BPI Certified Commercially Compostable Product

Folded Take Out Boxes

AmerCareRoyal's folded take out boxes are great for lunches, entrees or desserts to go. Made with poly-coated interiors, these containers are not only leak- and grease-resistant, but are strong enough to hold heavy foods, sauces and gravies. These cut-resistant boxes open wide to allow easy access to food, while closing tight to keep both hot and cold food fresh. With the convenient one-piece design, no assembly or lid inventory is required.

AmerCareRoyal folded take out boxes are microwavable and available in a variety of sizes and colors to accommodate every item on your menu.

Series	Item	Color	Dimensions	Pack	Weight	Cube
#1	FTB1BK	●	4¾" x 3½" x 2½"	9/50	25.3 lbs	3.46
	FTB1N	●	4¾" x 3½" x 2½"	9/50	25.3 lbs	3.68
	FTB1W	○	4¾" x 3½" x 2½"	9/50	25.3 lbs	3.64
#2	FTB2BK	●	7¾" x 5½" x 1⅞"	4/50	17.8 lbs	2.86
	FTB2N	●	7¾" x 5½" x 1⅞"	4/50	17.8 lbs	2.78
	FTB2W	○	7¾" x 5½" x 1⅞"	4/50	17.8 lbs	2.86
#3	FTB3BK	●	7¾" x 5½" x 2½"	4/50	20.2 lbs	3.16
	FTB3N	●	7¾" x 5½" x 2½"	4/50	20.2 lbs	3.49
	FTB3W	○	7¾" x 5½" x 2½"	4/50	20.2 lbs	3.16
#4	FTB4BK	●	7¾" x 5½" x 3½"	4/40	21.8 lbs	3.72
	FTB4N	●	7¾" x 5½" x 3½"	4/40	21.8 lbs	3.72
	FTB4W	○	7¾" x 5½" x 3½"	4/40	21.8 lbs	3.72
#5	FTB5BK	●	8½" x 8½" x 2½"	4/35	25.4 lbs	5.34
	FTB5N	●	8½" x 8½" x 2½"	4/35	24.3 lbs	5.34
	FTB5W	○	8½" x 8½" x 2½"	4/35	25.4 lbs	5.34
#8	FTB8BK	●	6" x 4¾" x 2½"	6/50	25.3 lbs	3.50
	FTB8N	●	6" x 4¾" x 2½"	6/50	25.3 lbs	3.64
	FTB8W	○	6" x 4¾" x 2½"	6/50	25.3 lbs	3.50

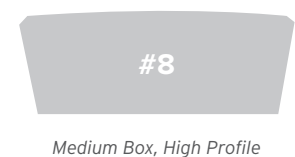
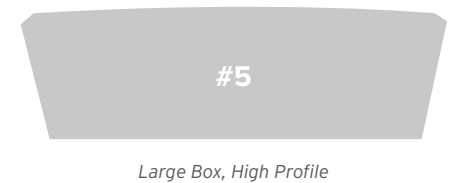
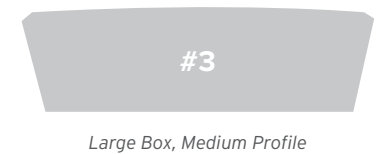
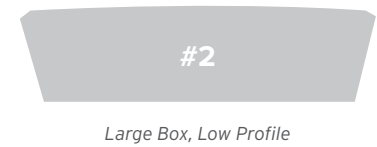

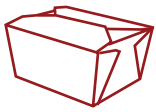

Take Out Packaging



Check out our napkins on **Page 83** & our cutlery on **Page 3!**

TGC2CS32B(without lid) and TGCR16B

Microwavable To-Go Containers

AmerCareRoyal's microwavable to go containers are ideal for take out or to-go orders. Made from BPA-free sturdy polypropylene, AmerCareRoyal's microwavable, dishwasher, freezer and heat lamp safe containers have clear seal-tight lids, to insure order accuracy. Perfect for salads, soups, sauces, dips and more, they can go from the fridge or freezer right to the microwave. Use these over and over again at home or at the restaurant.

- Black with clear lid
- Made from BPA-free polypropylene materials
- Lid included
- Microwave, dishwasher and freezer safe
- Compartment combo containers available



Rectangular Microwaveable To Go Combo

Black with Clear Lid

Item	Size	Dimensions	Pack	Weight	Cube
TGCS12B	12oz	6" x 4½" x 1½"	1/150	9.1 lbs	0.67
TGCS24B	24oz	7¾" x 5½" x 1½"	1/150	12.6 lbs	1.08
TGCS28B	28oz	8¾" x 6" x 1½"	1/150	15.1 lbs	1.21
TGCS32B	32oz	8¾" x 6" x 1½"	1/150	15.7 lbs	1.29
TGCS38B	38oz	8¾" x 6" x 2"	1/150	16.4 lbs	1.38



Round Microwaveable To Go Combo

Black with Clear Lid

Item	Size	Dimensions	Pack	Weight	Cube
TGCR16B	16oz	6" x 1½"	1/150	9.3 lbs	0.93
TGCR24B	24oz	7" x 1½"	1/150	12.2 lbs	1.20
TGCR32B	32oz	7" x 2"	1/150	12.7 lbs	1.26
TGCR38B	38oz	7" x 3"	1/150	15.7 lbs	1.39
TGCR48B	48oz	7" x 1½"	1/150	21.2 lbs	2.05



Compartment Microwaveable To Go Combo

Black with Clear Lid

Item	Size	Sections	Dimensions	Pack	Weight	Cube
TGC3CR33B	33oz	3	8½" x 1¾"	1/150	20.7 lbs	1.26
TGC2CS32B	32oz	2	8¾" x 6" x 2"	1/150	16.2 lbs	0.92
TGC3CS33B	33oz	3	10" x 7½" x 1¾"	1/150	24.0 lbs	1.20



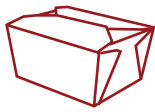

Take Out Packaging



DC12240C

Deli Containers

Easily package, store and transport food items with our heavy weight polypropylene deli containers. These translucent deli containers allow for delis, restaurants, and grocery stores to keep food safe while visible to customers.

- Perfect for soups, salads, dips and more
- Tight fitting lid to prevent messes
- Clear lid for visibility
- Available in a variety of sizes
- Reusable and recyclable
- Microwave, dishwasher & freezer safe

Bulk Deli Containers & Lid

Item	Size	Dimensions	Pack	Weight	Cube
DC08480	8oz	4½" x 1¾"	1/480	11.1 lbs	1.63
DC16480	16oz	4½" x 2½"	1/480	15.2 lbs	2.03
DC32480	32oz	4½" x 3"	1/480	24 lbs	3.99
DCL0832	8oz-32oz	4½" Lid	1/480	12.2 lbs	1.49

Bulk Deli Container Combos

Item	Size	Dimensions	Pack	Weight	Cube
DC08240C	8oz	4½" x 1¾"	1/240	11.5 lbs	1.63
DC12240C	12oz	4½" x 2½"	1/240	13.2 lbs	1.71
DC16240C	16oz	4½" x 3"	1/240	15.2 lbs	1.86
DC24240C	24oz	4½" x 4¼"	1/240	21.6 lbs	2.18
DC32240C	32oz	4½" x 5½"	1/240	24.0 lbs	2.90





HL-96-2, HL-93 and HL-66

Hinged Lid Containers

AmerCareRoyal's hinged lid containers are made from molded fiber and are compostable. Use these containers for take out foods containing added moisture or sauces.

PLA-lined containers are available as well. Perfect for handling hot and greasy foods, as well as helps stop contents from leaking.



Dimensions	Item	PLA Lined	Sections	Pack	Weight	Cube
6" x 6" x 3½"	HL-66*			4/125	24.6 lbs	1.70
7⅞" x 8" x 2½"	HL-81*			2/100	16.9 lbs	1.24
	HL-83*		3	2/100	16.9 lbs	1.27
7⅞" x 8" x 3½"	DHL-81*			2/100	18.3 lbs	1.32
	DHL-83*		3	2/100	18.3 lbs	1.28
	D-PLA-18*	✓		2/80	13.8 lbs	1.05
9" x 6"	D-PLA-38*	✓	3	2/80	13.8 lbs	1.05
	HL-96*			2/125	18.0 lbs	1.26
9" x 9" x 3½"	HL-96-2*		2	2/125	19.1 lbs	1.68
	HL-91*			2/100	20.0 lbs	1.51
	HL-93*		3	2/100	20.0 lbs	1.51
	PLA-19*	✓		2/80	15.6 lbs	1.20
	PLA-39*	✓	3	2/80	15.6 lbs	1.20



PrimeWare
Sustainable Product



BPI Certified
Commercially Compostable Product



PC-02, PCL-02, CPC-2, CPCL-2, CPC-325 and CPCL-34

Portion Cups

Perfect for restaurants, concession stands, cafés, cafeterias and food trucks, AmerCareRoyal has a complete line of portion cups and lids to hold additional sides, condiments, sauces and dips.

- Perfect for dips, condiments and side items
- Offered in a variety of sizes, colors and eco-friendly options
- Fiber portion cups are BPI certified compostable
- Freezer safe



PrimeWare
Sustainable Product



BPI Certified
Commercially Compostable Product



Plastic Portion Cups

	Size	Item	Color	Pack	Weight	Cube
Cups	1oz	PCP100C	☼	1/2500	6.7 lbs	0.68
	1.5oz	PCP150B	●	1/2500	9.9 lbs	1.51
		PCP150C	☼	1/2500	11.9 lbs	1.55
	2oz	PCP200B	●	1/2500	12.8 lbs	1.43
		PCP200C	☼	1/2500	14.1 lbs	1.63
	2.5oz	PCP250B	●	1/2500	13.8 lbs	1.57
		PCP325B	●	1/2500	20.9 lbs	2.30
	3.25oz	PCP325C	☼	1/2500	19.6 lbs	2.31
		PCP400B	●	1/2500	21.7 lbs	2.33
	4oz	PCP400C	☼	1/2500	22.0 lbs	2.29
Lids	1oz	PCLT1	☼	1/2500	3.9 lbs	0.64
	1.5-2.5oz	PCLT2	☼	1/2500	7.0 lbs	1.29
	3.25-4oz	PCLTL	☼	1/2500	10.1 lbs	1.68



PLA Portion Cups

	Size	Item	Color	Pack	Weight	Cube
Cups	2oz	CPC-2	☼	10/250	12.8 lbs	1.19
	3.25oz	CPC-325	☼	10/250	16.5 lbs	2.39
	4oz	CPC-4	☼	10/250	8.4 lbs	1.54
Lids	2oz	CPCL-2	☼	10/250	17.0 lbs	2.15
	3.25-4oz	CPCL-34	☼	10/250	11.5 lbs	2.18



Fiber Portion Cups

	Size	Item	Color	Pack	Weight	Cube
Cups	2oz	PC-02*	○	25/100	18.0 lbs	1.20
Lids	2oz	PCL-02*	○	25/100	12.5 lbs	1.60

Pizza Savers

- Prevent box crushing or cheese and other pizza toppings from sticking to the box tops
- Disposable & stackable
- Available in tripod and tabletop styles
- Can withstand high temperatures
- A must-have for any pizza parlor



Item	Description	Pack	Weight	Cube
RPS1M	Tabletop 1½"	10/100	4.9 lbs	0.27
RPS1MT	Tall Tabletop 2"	10/100	7.6 lbs	0.48
RPST2M	Tripod 1½"	1/2000	6.4 lbs	0.94

Pizza Slice Holder

- Makes it easier to serve up single slices of hot pizza
- Laminated paperboard protects customers' hands and clothes by preventing grease from soaking through
- Scored flaps for easy folding



Item	Pack	Weight	Cube
RPSH1000	4/250	18.7 lbs	0.61

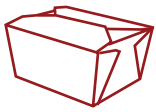

Take Out Packaging



CTBS962 and CTBM993

Check out our napkins on Page 83 & our cutlery on Page 3!

Corrugated Take Out and Catering Boxes

AmerCareRoyal corrugated take out and catering boxes feature a sturdy angled design allowing for secure transport and help maintaining food integrity for both take-out and delivery. These stackable boxes are an ideal alternative to foam packaging.

- Easily transport prepared food in foil pans
- Insulates during food delivery
- Five sizes available
- Only available in white



Corrugated Take Out Boxes

White

Item	Size	Dimensions	Pack	Weight	Cube
CTBS962	Small	8 ⁷ / ₈ " x 5 ⁷ / ₈ " x 2"	1/50	8.0 lbs	0.53
CTBM993	Medium	8 ⁷ / ₈ " x 8 ⁷ / ₈ " x 2 ⁷ / ₈ "	1/50	13.1 lbs	0.94
CTBL1163	Long	11 ³ / ₈ " x 5 ⁵ / ₈ " x 2 ⁵ / ₈ "	1/50	11.0 lbs	0.78



- Chicken wings
- Mozzarella sticks



- Burgers
- Sandwiches/wraps
- French fries



- Cheesesteaks
- Fried fish
- Hoagies/grinders/subs

Corrugated Catering Boxes

White

Item	Size	Dimensions	Pack	Weight	Cube
CCBFP21133	Full Pan	21" x 13" x 3"	1/50	38.0 lbs	3.67
CCBHP13113	Half Pan	13" x 10 ⁷ / ₈ " x 3"	1/50	23.0 lbs	2.13



Head over to **Page 14** to get a look at our catering utensils!

- Hot dishes
- Pasta
- Salads

Corrugated Carry Out Box

Kraft with Handle

Item	Dimensions	Pack	Weight	Cube
CHTB221312	22" x 13" x 12 ¹ / ₂ "	1/25	26.0 lbs	3.02



- Stack pans or boxes
- Holds up to 65 lbs



- Family style meals
- Multiple food items



Take Out Packaging



DP-105, DP-66 and DP-10

Tableware

AmerCareRoyal offers a wide selection of tableware, including plates, bowls, trays, forks, knives and spoons. Disposable tableware makes preparing for any event easy and cost-effective. Eco-friendly compostable options are available for those looking to go green.

Plates & Lids



	Item	Description	Pack	Weight	Cube
Square	DP-66*	6" Plate	4/125	18.0 lbs	0.66
	DP-88*	8" Plate	4/125	23.5 lbs	0.90
	DP-10*	10" Plate	2/125	18.0 lbs	0.76
	DPL-66	6" Lid	4/125	16.9 lbs	2.24
	DPL-88	8" Lid	4/125	26.2 lbs	2.72
	DPL-10	10" Lid	2/125	23.2 lbs	1.83
Rectangle	DP-105*	10" x 5" Plate	4/125	20.2 lbs	0.93
	DPL-105*	10" x 5" Lid	4/125	23.1 lbs	2.36
Round	PL-06*	6" Plate	8/125	15.4 lbs	1.08
	PL-07*	7" Plate	8/125	20.2 lbs	1.50
	PL-09*	9" Plate	4/125	18.0 lbs	1.43
	PL-10*	10" Plate	4/125	23.5 lbs	1.83
	PL-93*	9" Plate - 3 Section	4/125	18.0 lbs	1.39
	PL-11*	10" Plate - 3 Section	4/125	24.6 lbs	1.81
Platter	PL-16-1*	10¼" x 7¾" Platter	4/125	20.5 lbs	1.42
	PL-16-2*	12½" x 10" Platter	4/125	32.5 lbs	2.21



- Perfect for takeout, food trucks, catering events, weddings and more
- Plate and lid combos allow for easy storage of leftovers
- Molded fiber bowls are perfect green solution that is both compostable and disposable
- PET lids are both disposable and recyclable
- Perfect for serving appetizers, main dishes and sides



PrimeWare
Sustainable Product



BPI Certified
Commercially Compostable Product

Bowls & Lids

- A versatile option perfect for takeout, food trucks, catering events, weddings and more
- Molded fiber bowls are perfect green solution that is both compostable and disposable
- Bowl and lid combos allow for easy storage of leftovers
- PET lids are both disposable and recyclable
- Perfect for serving soups, salads and more

	Item	Description	Pack	Weight	Cube
Oval	BB-20 *	20oz Bowl	4/125	18.1 lbs	1.21
	BB-24 *	24oz Bowl	2/125	12.5 lbs	1.01
	BB-32 *	32oz Bowl	2/125	15.7 lbs	1.51
	BBL-20	20oz Lid	4/125	8.4 lbs	2.80
	BBL-24	24oz Lid	2/125	7.2 lbs	1.71
	BBL-32	32oz Lid	2/125	7.3 lbs	2.51
Round	BL-12 *	12oz Bowl	8/125	23.5 lbs	2.01
	BL-16 *	16oz Bowl	8/125	28.0 lbs	2.82
Square	DP-12B *	12oz Bowl	4/125	12.5 lbs	0.71
	DPL-12B	12oz Lid	4/125	14.7 lbs	2.13
Square, Tan	DPT-24B	24oz Bowl	4/75	14.1 lbs	1.21
	DPT-32B	32oz Bowl	4/75	18.7 lbs	1.29
	DPT-40B	40oz Bowl	4/75	20.7 lbs	2.17
	DPL-2440	24oz, 32oz, 40oz Clear Lid	4/75	10.4 lbs	3.03
Round, Tan	TB-32 *	32oz Bowl	4/75	18.0 lbs	1.61
	TBL-32	32oz Clear Lid	4/75	14.7 lbs	2.56
Tub, Tan	TDC-79 *	Deep Tub 7" x 9" x 3 1/8"	4/50	18.3 lbs	2.02
	TSC-79 *	Shallow Tub 7" x 9" x 2 1/4"	4/50	13.8 lbs	1.77
	TCL-79 *	7" x 9" Fiber Lid	4/50	10.8 lbs	1.19
	TCL-PET-79	7" x 9" Clear Lid	4/50	11.3 lbs	1.55



Trays

	Item	Description	Pack	Weight	Cube
Compartment	NT-79	3 Section Nacho	4/125	30.9 lbs	3.26
	TL-15 *	5 Section	4/125	32.4 lbs	2.01
	TL-15-T *	5 Section Value	4/125	26.9 lbs	1.77
	TL-16 *	6 Section	2/125	22.4 lbs	1.28
Fiber, Tan	TRAY-14D *	6 1/10" x 5.7" x 1 1/2"	4/125	20.9 lbs	1.30
	TRAY-14S *	6" x 6" x 7/8"	4/125	16.5 lbs	0.71
	TRAY-17S *	8 3/10" x 4 1/2" x 5/10"	4/125	18.7 lbs	1.09
	TRAY-2DP *	8 9/10" x 6 1/2" x 1"	4/125	25.4 lbs	2.04
	TRAY-2S *	8" x 5 3/4" x 5/10"	4/125	22.0 lbs	1.34
	TRAY-4D *	9 4/10" x 6 9/10" x 1 1/10"	2/125	18.2 lbs	1.29
	TRAY-104 *	10 1/4" x 4 4/10" x 1"	4/125	22 lbs	1.17



- Made from molded fiber or bagasse materials
- Compostable and disposable
- Perfect selection for eco-friendly option and foam alternative
- Perfect for cafeterias, using multiple compartments for serving sandwiches, nachos, sides, main dishes and more

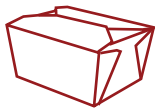

Take Out Packaging



Check out our napkins on Page 83 & our cutlery on Page 3!

RPWB1918HD and TBRH2214HD

Bags

AmerCareRoyal poly take out bags are for use in grocery stores, retail shops, restaurants and convenience stores.

Multilingual Take Out Bags

- Supports a variety of take out needs from small single take out boxes up to 2 full size steam pans for catering
- Large flat bottom designed to allow containers to sit flat for extra stability during transit
- Made from high density polyethylene (HDPE), higher heat threshold compared to low-density polyethylene (LDPE)
- Can be ordered as die cut or rigid handle shopping bags, t-shirt bags or wave top bags

Item	Description	Dimensions	Pack	Weight	Cube
RPWB1918HD	Wave Top Handled Shopping Bag	19" x 18" x 9½"	1/500	13.9 lbs	0.35
TBDC1210HD	Die Cut Handled Shopping Bag	12" x 10" x 17"	1/200	12.7 lbs	0.50
TBDC85HD	Die Cut Handled Shopping Bag	8" x 5" x 14"	1/200	5.6 lbs	0.26
TBFB1110HD	Flat Bottom T-Shirt Bag	11½" x 10½" x 19"	1/250	9.4 lbs	0.45
TBRH1410HD	Rigid Handled Shopping Bag	14" x 10" x 15"	1/100	18.1 lbs	1.26
TBRH1910HD	Rigid Handled Shopping Bag	19" x 10" x 12"	1/100	22.4 lbs	1.47
TBRH2214HD	Rigid Handled Shopping Bag	22" x 14" x 15"	1/50	17.4 lbs	1.39





RPWB1919

- Accommodates 4 9" containers
- Made of extra strong low-density polyethylene unlike many lower quality high density polyethylene wave style bags
- Features sturdy carrying handles and is designed to sit open on a counter for convenient and easy packaging
- The large bottom allows containers to sit flat, providing extra stability during transit



RPTYB6



RPTYB6G



RPBAG-RK6

- Carry take-out orders and store items with ease
- Designed to easily pack items
- Choose from a variety of sizes and styles or create your own custom design
- 1/6 Size Poly Bag Rack designed to organize and dispense AmerCareRoyal's Poly Take Out Bags one at a time

Plastic Take Out Bags

Item	Description	Dimensions	Pack	Weight	Cube
RPWB1919	Wave Top To Go Bag	19" x 19" x 9½"	1/500	17.0 lbs	0.46
RPPBB6	Plain Black Bag	11½" x 6½" x 21½"	1/1000	10.4 lbs	0.42
RPPWB10	Plain White Bag	8" x 5" x 15"	1/1800	10.6 lbs	0.40
RPPWB6	1/6 Plain White Bag	11½" x 6½" x 22"	1/1000	10.4 lbs	0.42
RPTYB6	1/6 Thank You Bag	11½" x 6½" x 21"	1/1000	11.1 lbs	0.37
RPTYB6FS	1/6 Thank You Bag	13" x 8" x 23"	1/1000	17.4 lbs	0.54
RPTYB6G	1/6 Thank You/Gracias Bag (Spanish & English)	11½" x 6½" x 21"	1/800	8.5 lbs	0.29
RPTYB6HW	1/6 Thank You Bag, Heavy Weight	11½" x 6½" x 22"	1/600	10.7 lbs	0.42
RPTYB6V	1/6 Thank You Bag, 11 Mic	11½" x 6½" x 20"	1/775	7.7 lbs	0.25
RPTYB8	1/8 Thank You Bag, 15 Mic	10" x 5" x 18"	1/1000	9.8 lbs	0.45
RPBAG-RK6	1/6 Poly Bag Rack - fits Thank You bags		1/2	12.1 lbs	1.76



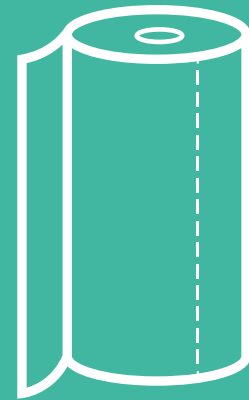

TOWELS & WIPES

AmerCareRoyal offers an array of food service towels for keeping your table surfaces and kitchen clean.

Also available are bath tissues, towels and gentle personal hygiene options for bathroom sanitation.

Food Service Towels	143
Wipes	144
Bath Tissues & Towels	144

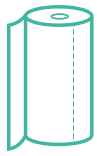

Towels & Wipes



RP11550

Foodservice Towels

From wiping sauce off tables to cleaning debris around kitchen countertops, AmerCareRoyal's disposable non-woven towels make short work of dirty tasks. These extraordinarily durable towels are soft to the touch with increased thickness and absorbent material designed for multi-use, even large spills. Multi-color options make it easy to keep wipers separate based on specific usage.

Diamond Towels

RP11550, RP11490

- Quickly and effectively clean spills off tables, countertops, glass and more
- Lightweight, wet wiping towel
- Improved absorbency

Medium Weight Towels





RP11553, RP11555

- Increased thickness and absorbency provide ideal cleaning of sizable spills
- Soft and strong for general cleaning and light wet wiping tasks
- Easy rinse and washing machine safe
- Durability designed for multi-use

Catch All Towel

1317-200A

- Great for wiping spills and can be rinsed and re-used
- Non-woven towel used for general cleaning
- Economical option

Item	Color	Dimensions	Pack	Weight	Cube
RP11490		11" x 21½"	1/200	2.8 lbs	0.71
RP11550		11" x 21½"	1/200	5.4 lbs	0.71
RP11553		13" x 21½"	1/150	5.8 lbs	0.64
RP11555		13" x 21½"	1/150	5.8 lbs	0.64
1317-200A		13" x 17"	1/200	3.3 lbs	0.30

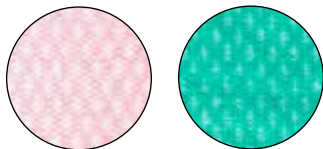

Diamond Towels

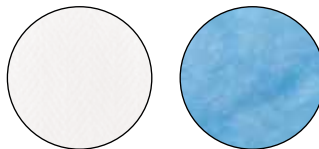

Medium Weight Towels

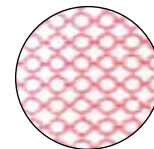

Catch All Towel



Wipes

Pre-moistened Washcloths

- Hypoallergenic mild scent
- Easy dispensing
- Quad fold
- Extra soft and non-irritating
- Pre-moistened with lanolin
- Keep lid tightly closed and store at room temperature
- Do not flush



Flushcare Flushable Wipes

- Septic and wastewater treatment system safe
- Alcohol free
- Soft to the touch spunlace material
- Pre-moistened with aloe and lanolin

Baby Wipes

- Extra soft, convenient and pre-moistened with gentle cleansing solution
- Includes Aloe Vera that has been clinically tested for mildness
- Hypoallergenic and alcohol free
- Pop up, resealable pouch

Item	Pre-moistened	Adult Care	Baby Wipe	Flushable	Unscented	Refill	Dimensions	Pack	Weight	Cube
W0912	✓	✓					9" x 12"	12/72	24.2 lbs	1.03
WF0911	✓		✓				9" x 11"	9/60	18.7 lbs	1.04
RPBWUR-80	✓	✓		✓	✓		N/A	12/80	13.7 lbs	0.52
RPBWU-80	✓	✓		✓			N/A	12/80	16.3 lbs	1.12
RPBWSR-80	✓	✓			✓		N/A	12/80	13.7 lbs	0.52
RPBWS-80	✓	✓					N/A	12/80	16.3 lbs	1.12

Bath Tissues & Towels

- Economical choice for restroom facilities
- Perfect for any restaurant or bar bathroom
- Various sizes available
- Folded towels and rolls towels available



	Item	Roll	Ply	Fold	Core	Color	Dimensions	Pack	Weight	Cube
Tissue	TR2P1000		2			○	3.43" x 1000'	1/12	22.3 lbs	2.20
	VON5022		2		1.65"	○	4½" x 3.6"	1/96	39 lbs	4.86
	TR2P0800		2			○	3.55" x 800'	1/12	17.2 lbs	2.04
Towel	VON4100	✓	2			○	8.8" x 11"	1/30	18 lbs	4.13
	CPW2P575	✓	2			○	7.6" x 575'	1/6	20.3 lbs	1.83
	RTKR350	✓	1		2"	●	7¾" x 350'	1/12	21 lbs	1.69
	FTKRMF		1	M	-	●	8½" x 9½"	16/250	17.2 lbs	1.42
	FTWRFC		1	C	-	○	9" x 13"	12/200	13.9 lbs	1.38
	RTKR600	✓	1		2"	●	7.75" x 600'	1/12	35.1 lbs	2.94
	RTWR600	✓	1		2"	○	7.75" x 600'	1/12	38.7 lbs	2.98

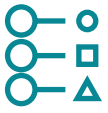

TGCS24B

Tulip Cups

- Made from grease-proof paper to retain moisture and promote even baking
- Can also be used for displaying other delicious non-baked products, such as chocolates and candy apples
- Approved for baking in conventional ovens up to 425°F
- Available in a variety of sizes

Baking Cups

- Specially designed packaging maintains clean cups and perfect shapes
- White dry wax treated paper eliminates pan greasing
- De-nesting feature promises quick and easy use
- Perfect for cupcakes, muffins and other confections
- Available in a variety of sizes

Back
of house

Baking Cups

Style	Item	Size	Color	Blank	Bottom	Wall	Pack	Weight	Cube
Tulip	TGCS12B	2oz	●	5 ⁷ / ₈ "	2"	2" x 3 ³ / ₁₆ "	10/200	6 lbs	1.40
	TGCS24B	3oz	●	6 ¹ / ₄ "	2"	2 ¹ / ₈ " x 3 ³ / ₈ "	10/200	7 lbs	1.40
	TGCS28B	4oz	●	6 ⁷ / ₈ "	2"	2 ¹ / ₈ " x 3 ¹³ / ₁₆ "	10/200	8 lbs	1.40
Baking	RP112-35	3 ¹ / ₂ "	○	4 ¹ / ₂ "	2"	1"	20/500	6.3 lbs	0.44
	RP114-3	3"	○	3"	1 ¹ / ₄ "	7 ⁸ / ₈ "	20/500	6 lbs	0.44
	RP200-45	4 ¹ / ₂ "	○	4 ¹ / ₂ "	2"	1 ¹ / ₄ "	20/500	10.7 lbs	1.00
	RP200-55	5 ¹ / ₂ "	○	5 ¹ / ₂ "	2"	1 ⁷ / ₈ "	20/500	9.6 lbs	1.50
	RP214-6	6"	○	6"	2 ¹ / ₄ "	1 ⁷ / ₈ "	20/500	18.8 lbs	1.50

How to Size a Baking Cup

Baking Cup dimensions consist of three measurements:

1. The blank
2. The base of bottom diameter
3. The side wall height

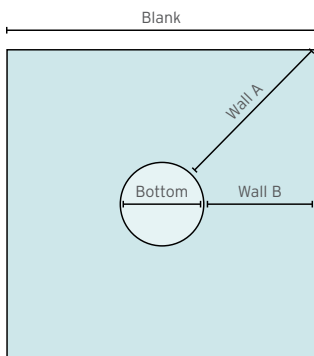

Tulip Cups

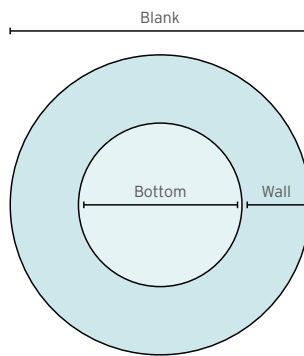

Baking Cups





Chafing Fuel

AmerCareRoyal represent a variety of chafing fuel options while delivering high heat output, consistent burn times and great value.

For safety, make sure chafing fuel can is secured in place before lighting.





Wick Chafing Fuel

- A non-alcohol Diethylene Glycol (DEG) wick style heat source
- Provides a convenient screw top for easy extinguishing and safe storage for reuse
- Medium width odorless flame keeps food warm while the cans remain cool to the touch
- Safe, non-poisonous, and efficient product delivers a clean-burning solution for all your buffet, catering and food service needs

Burn Time	Item	Guardian	ReadyWick	SteadyWick	Pack	Weight	Cube
2 HR	SW2H24		✓		1/24	6.9 lbs	0.34
	SW4H24			✓	1/24	10.8 lbs	0.38
4 HR	RW4H24		✓		1/24	11.5 lbs	0.44
	GP4H24	✓			1/24	16.1 lbs	0.44
6 HR	SW6H24			✓	1/24	15.4 lbs	0.54
	RW6H24		✓		1/24	16 lbs	0.51
	GP6H24	✓			1/24	18 lbs	0.47

Ethanol Gel Chafing Fuel

- Perfect for restaurants, buffets, catering, wholesale or any foodservice operation
- Bio-based ethanol gel is a corn-based biofuel that promotes a safer, cleaner and healthier environment
- Easy to light and provides a strong heat output option

Burn Time	Item	Pack	Weight	Cube
2 HR	GE2H72	1/72	33.7 lbs	0.92



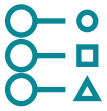

Lemon Wraps & Wedges

- Add some flair to table settings with AmerCareRoyal's selection of lemon wraps
- Designed to prevent customers' fingers from coming in direct contact with lemon pieces
- Keep seeds out of your food

Available in:

- Yellow
- Flat yellow wrap with green ribbon
- White
- Flat white wrap with green ribbon

Item	Wedge Bags	Ribbon Wrap	Color	Pack	Weight	Cube
RLWB25W	✓		○	25/100	5.2 lbs	1.18
RLWB25	✓		●	25/100	5.2 lbs	1.18
RLC10Y		✓	●	4/250	5 lbs	0.58
RLC10W		✓	○	4/250	5 lbs	0.58

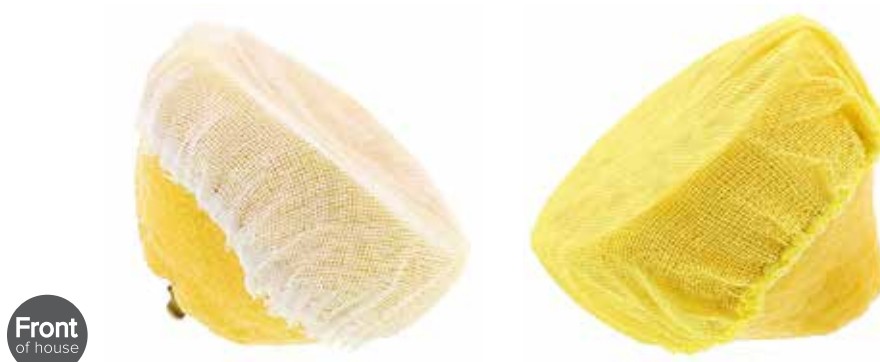

Front of house



Food Shells

- Designed to enhance the presentation of dishes and used for portion control
- Variety of shapes including clamshell styles available
- Perfect for any foodservice operation

Item	Size	Color	Pack	Weight	Cube
L7EP	Crab	●	4/250	4.4 lbs	0.32
L5PG	Potato	●	2/250	4.2 lbs	0.48
L103P	King	●	4/250	6.6 lbs	0.6
L102P	Small	●	8/250	8.8 lbs	1.07

Chop Holders

- Used on the end of lamb, veal, pork chops etc as decoration
- Assorted colors add a festive touch to your items

Item	Color	Material	Pack	Weight	Cube
R819	○	Paper	10/250	4 lbs	0.79
R817	●	Foil	10/250	4 lbs	0.79
R816	●●●●	Paper	10/250	4 lbs	0.79



Poly Banquet Roll

- Perfect for parties, banquets, outside dining and more
- Provide a clean and neat table surface on a cut-to-fit roll
- Disposable for easy clean up
- Stronger than paper

Item	Size	Pack	Weight	Cube
TCD	40" x 300'	1/6	25.4 lbs	1.39



Red Vinyl Basket

- Great alternative to traditional dishes
- Saves time and money
- Use in combination with disposable basket liners
- Perfect for use in restaurants, hospitals, diners or any eating establishment

Item	Dimensions	Pack	Weight	Cube
V21A	9½" x 6¼" x 2"	1/36	4.9 lbs	0.56



Aluminum Ashtrays

- Ideal for use in restaurants, bars and cafes
- Choose from silver or gold star styles that are durable and easy to clean
- Foldable for easy recycling

Item	Color	Pack	Weight	Cube
LA201P	○	4/250	8.4 lbs	0.41
LA200P	●	4/250	9 lbs	0.41



Wobble Wedges

- Perfectly designed to fix wobbly tables
- Can be cut down to the required size with a knife or scissors
- Made from soft plastic and are stackable

Item	Pack	Weight	Cube
WWSBK1230	12/30	5.8 lbs	0.28



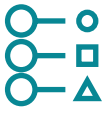

Hotel & Motel Products

AmerCareRoyal's hotel and motel products bring upscale details that keep guests impressed and help your establishment run smoothly. We offer premium quality products, like oval waste basket liners, paper shower slippers, plain white bath mats, sanitary bags, toilet seat bands and water glass bags. All our products are made from a variety of durable, high-quality materials and are designed to add to the ambiance of your hotel or motel.



Bath Mats

- Disposable bath mats help keep bath and shower areas sanitary
- Perfect for protecting customers from slips and falls on slippery floors
- Ideal for use in hotel and motel operations

Item	Dimensions	Color	Pack	Weight	Cube
BMPW	Approx 14" x 20-1/2"	○	1/500	24.7 lbs	0.82

Sanitary Bags

- AmerCareRoyal's selection of sanitary bags are ideal for use in restaurant, hotel and motel bathrooms and are a great way to keep restrooms organized and hygienic
- Sanitary bags allow for discreet napkin disposal and are leak resistant

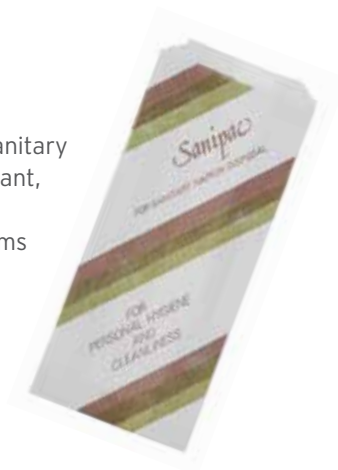

Item	Pack	Weight	Cube
RHM2	1/1000	8 lbs	0.57



Shower Slippers

- Durable, disposable shower slippers help ensure customer comfort
- Paper slippers are ideal for use in motels, hotels, and hospitals, spas and are designed to keep feet sanitary

Item	Pack	Weight	Cube
RHM6P	40/50	28.6 lbs	2.65

Toilet Seat Bands

- Selection of toilet seat bands are designed to slip over any standard sized toilet to let customers know that the toilet has been cleaned
- Feature the inscription "Sanitized for your protection" and are guaranteed to promote cleanliness at any establishment

Item	Pack	Weight	Cube
RHM3	1/2000	7.3 lbs	0.19

Waste Basket Liners

- Ensure cleanliness at any establishment with waste basket liners
- Designed to fit into any standard sized waste bin
- Help prevent messy spills and leaks from staining the sides of waste bins

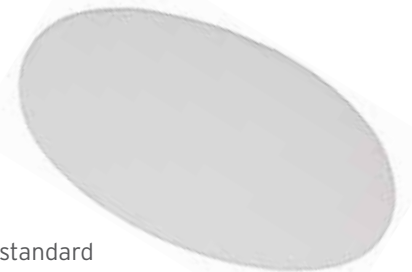

Item	Pack	Weight	Cube
RHM5	1/3000	14.8 lbs	0.52

Water Glass Bags

- Keep water glasses packaged and sanitary before use with water glass bags
- Ideal for use in hospitals, hotels, or motels, they ensure guests receive only the cleanest and cleanest of glasses and are sure to impress



Item	Pack	Weight	Cube
RHM1	10/1000	61 lbs	3.79





PrimeWare®

PrimeWare® by AmerCareRoyal™ is a line of eco-friendly products that offer a variety of disposable take out packaging, cutlery, cups and straws. These items are perfect for restaurants, bars, catering and much more!

Hinged Lid Containers.....	155
Compostable Food Containers.....	156
Portion Cups.....	157
Cutlery.....	159
Straws.....	160
Cold Cups & Lids.....	161
Cup Carriers.....	161
Hot Cups & Lids.....	162
Tableware.....	163



HL-96-2, HL-66, HL-93

Hinged Lid Containers

AmerCareRoyal's hinged lid containers are made from molded fiber and are compostable. Use these containers for take out foods containing added moisture or sauces.

PLA-lined containers are available as well. Perfect for handling hot and greasy foods, as well as helps stop contents from leaking.



BPI Certified
Commercially Compostable
Product

Hinged Lid Containers



Dimensions	Item	PLA Lined	Sections	Pack	Weight	Cube
6" x 6" x 3 1/5"	HL-66*			4/125	24.6 lbs	1.70
7 7/8" x 8" x 2 1/2"	HL-81*			2/100	16.9 lbs	1.24
	HL-83*		3	2/100	16.9 lbs	1.27
7 7/8" x 8" x 3 1/5"	DHL-81*			2/100	18.3 lbs	1.32
	DHL-83*		3	2/100	18.3 lbs	1.28
	D-PLA-18*	✓		2/80	13.8 lbs	1.05
	D-PLA-38*	✓	3	2/80	13.8 lbs	1.05
9" x 6"	HL-96*			2/125	18.0 lbs	1.26
	HL-96-2*		2	2/125	19.1 lbs	1.68
9" x 9" x 3 1/5"	HL-91*			2/100	20.0 lbs	1.51
	HL-93*		3	2/100	20.0 lbs	1.51
	PLA-19*	✓		2/80	15.6 lbs	1.20
	PLA-39*	✓	3	2/80	15.6 lbs	1.20

Compostable Hot and Cold Food Containers



PLA Lined Paper Containers and CPLA Lids

- PLA-lined to keep food fresh
- Food containers feature a patterned design
- Fully compostable
- Can be topped with compostable CPLA lids

	Size	Item	Color	Pack	Weight	Cube
Containers	8oz	FC-8*	○	2/100	18.3 lbs	1.32
	12oz	FC-12*	○	2/100	18.3 lbs	1.28
	16oz	FC-16*	○	2/80	13.8 lbs	1.05
	32oz	FC-32*	○	2/80	13.8 lbs	1.05
Lids	8oz	CFCL-8*	○	4/125	24.6 lbs	1.70
	12-32oz	CFCL-1232*	○	2/100	16.9 lbs	1.24



BPI Certified
Commercially Compostable
Product



Portion Cups

Portion Cups

Perfect for restaurants, concession stands, cafés, cafeterias and food trucks, AmerCareRoyal has a complete line of portion cups and lids to hold additional sides, condiments, sauces and dips.

- Perfect for dips, condiments and side items
- Offered in a variety of sizes, colors and eco-friendly options
- BPI certified compostable
- Freezer safe

PLA Portion Cups

	Size	Item	Color	Pack	Weight	Cube
Cups	2oz	CPC-2	☼	10/250	12.8 lbs	1.19
	3.25oz	CPC-325	☼	10/250	16.5 lbs	2.39
	4oz	CPC-4	☼	10/250	8.4 lbs	1.54
Lids	2oz	CPCL-2	☼	10/250	17.0 lbs	2.15
	3.25-4oz	CPCL-34	☼	10/250	11.5 lbs	2.18

Fiber Portion Cups



	Size	Item	Color	Pack	Weight	Cube
Cups	2oz	PC-02*	○	25/100	18.0 lbs	1.21
Lids	2oz	PCL-02*	○	25/100	12.5 lbs	1.60



BPI Certified
Commercially Compostable
Product







CPLA Cutlery

Cutlery

CPLA Cutlery



- CPLA cutlery is made from renewable CPLA or modified corn-based plastic
- Can be used for either hot or cold foods
- FDA approved for food contact and ASTM compliant
- Ideal for higher heat applications and strong enough to stand up to any dish

Cutlery	Item	Color	Length (in)	Pack	Weight	Cube
Fork	BCPW-F*	●	6.5	20/50	11.5 lbs	0.45
	CPW-F*	○	6.5	20/50	12.3 lbs	0.53
Knife	BCPW-K*	●	6.5	20/50	11.5 lbs	0.36
	CPW-K*	○	6.5	20/50	11.4 lbs	0.48
Spoon	BCPW-S*	●	6.5	20/50	13.8 lbs	0.51
	CPW-S*	○	6.5	20/50	14.1 lbs	0.58
3pc Kit Fork, Knife, Spoon	WCPW-KIT	○	6.5	1/500	8.4 lbs	0.68

Plant Starch Cutlery

- PrimeWare by AmerCareRoyal plant starch or PSM cutlery made from plant starch material, produced from corn and potato starch
- Ideal for serving both hot and cold food items
- Water and oil proof
- Made from 80% PSM and 20% polypropylene materials, not compostable
- FDA approved for food contact

Cutlery	Item	Color	Length (in)	Pack	Weight	Cube
Fork	BPWF-7	●	7	20/50	14.9 lbs	0.80
	PWF-7	○	7	20/50	14.9 lbs	0.80
Knife	BPWK-7	●	7	20/50	14.9 lbs	0.74
	PWK-7	○	7	20/50	14.9 lbs	0.74
Spoon	BPWS-7	●	7	20/50	14.9 lbs	0.74
	PWS-7	○	7	20/50	14.9 lbs	0.75
Soup Spoon	BPWSS-7	●	7	20/50	16.7 lbs	0.67
	PWSS-7	○	7	20/50	16.7 lbs	0.67



BPI Certified
Commercially Compostable
Product



PLA Straws

Straws

PLA Straws

- Eco-friendly PLA straws are made from corn-based plastic
- Meet ASTM D6400 for compostability
- Paper wrapped and unwrapped styles available

Style	Item	Length (in)	Color	Paper Wrap	Pack	Weight	Cube
Jumbo	STNJML1970701	7¾"	☉		12/500	15.2 lbs	1.89
	STNJML1970702	7¾"	☉	✓	12/500	15.2 lbs	2.37
Giant	STNGTL2601001	10¼"	☉		12/300	14.3 lbs	1.98
	STNGTL2601002	10¼"	☉	✓	12/300	14.3 lbs	2.64

Paper Straws

- A great option for any eco-conscious foodservice location
- Function just like plastic
- Perfect for eco-friendly restaurants that operate in plastic ban municipalities

Style	Item	Length (in)	Color	Paper Wrap	Pack	Weight	Cube	
Cocktail	STNSLP1460501	5¾"	●		8/500	9.0 lbs	0.97	
	STNJMP1970701	7¾"	○		12/500	17.9 lbs	1.75	
	STNJMP1970702	7¾"	○	✓	12/500	20.9 lbs	2.63	
	STNJMP1970703	7¾"	○		8/500	11.7 lbs	1.28	
	STNJMP1970704	7¾"	●		8/500	11.7 lbs	1.28	
	STNJMP1970705	7¾"	●	✓	8/500	11.7 lbs	1.28	
	STNJMP1970706	7¾"	●	✓	8/500	11.7 lbs	1.28	
Jumbo	STNJMP1970707	7¾"	●		8/500	11.7 lbs	1.28	
	STNGTP1970701	7¾"	●		8/300	7.9 lbs	0.93	
	STNGTP2601001	10¼"	○		12/300	18.3 lbs	2.60	
	STNGTP2601002	10¼"	○	✓	12/300	21.4 lbs	3.66	
	STNGTP2601003	10¼"	○		8/300	8.4 lbs	1.20	
	Giant							





PLA Cold Cups and Lids

Paper Hot Cups and Lids

Disposable Cold Cups

PLA Cold Cups

- Made from PLA or corn-based plastic
- BPI certified compostable and meet ASTM D6400 for compostability
- Perfect cold beverages on the go

Size	Item	Color	Pack	Weight	Cube
9oz	CCP-9-SQ		20/50	19.4 lbs	2.57
12oz	CCP-12		20/50	23.6 lbs	3.04
16oz	CCP-16		20/50	28.9 lbs	3.59
20oz	CCP-20		20/50	37.3 lbs	4.19
24oz	CCP-24		12/50	20.5 lbs	2.52

PLA Cold Cup Lids

Size	Item	Color	Flat	Dome	Pack	Weight	Cube
9oz	CFL-9		✓		10/100	6.2 lbs	1.50
12oz-	CFL-1224		✓		10/100	6.8 lbs	1.52
24oz	CDL-1224			✓	20/50	9.9 lbs	2.06

Cup Carriers

- Designed to hold both hot and cold cups ranging from 8 to 32 oz
- Disposable and compostable
- Various sizes available

Item	Cup Size	Cups	Color	Pack	Weight	Cube
CC-832	8-32 oz	4		4/75	24.4 lbs	2.59
CC-802	8-24 oz	2		10/50	29.4 lbs	2.81
CC-2CupTray	8-32 oz	2 + Tray		2/125	23.5 lbs	2.10
CC-1232	12-32 oz	4		4/75	29.3 lbs	2.81



BPI Certified
Commercially Compostable
Product

Disposable Hot Cups



Paper Hot Cups
Compostable Paper, PLA Lined



Size	Item	Color	Pack	Weight	Cube
4oz	HC-4*	○	20/50	10.0 lbs	1.11
8oz	HC-8*	○	20/50	21.0 lbs	2.26
	W-HC-8	○	20/50	21.0 lbs	2.26
10oz	HC-10*	○	20/50	23.6 lbs	2.73
12oz	HC-12*	○	20/50	28.0 lbs	3.23
	W-HC-12	○	20/50	28.0 lbs	3.23
16oz	HC-16*	○	20/50	33.1 lbs	3.82
	W-HC-16	○	20/50	33.1 lbs	3.82
20oz	HC-20*	○	20/50	36.4 lbs	4.01
	W-HC-20	○	20/50	36.4 lbs	4.01



Hot Cup Lids



Size	Item	CPLA	Fiber	Color	Pack	Weight	Cube
8oz	CHCL-8*	✓	○	○	20/50	7.6 lbs	1.59
10oz - 20oz	CHCL-1020	✓	○	○	20/50	9.2 lbs	1.99
12oz - 20oz	HCL-1220*		✓	○	10/50	6.8 lbs	0.94



DP-105, DP-66, DP-10

Tableware

AmerCareRoyal offers a wide selection of tableware, including plates, bowls, trays, forks, knives and spoons. Disposable tableware makes preparing for any event easy and cost-effective. Eco-friendly compostable options are available for those looking to go green.

Plates & Lids



- Perfect for takeout, food trucks, catering events, weddings and more
- Plate and lid combos allow for easy storage of leftovers
- Molded fiber bowls are perfect green solution that is both compostable and disposable
- PET lids are both disposable and recyclable
- Perfect for serving appetizers, main dishes and sides



	Item	Description	Pack	Weight	Cube
Square	DP-66*	6" Plate	4/125	18.0 lbs	0.66
	DP-88*	8" Plate	4/125	23.5 lbs	0.90
	DP-10*	10" Plate	2/125	18.0 lbs	0.76
	DPL-66	6" Lid	4/125	16.9 lbs	2.24
	DPL-88	8" Lid	4/125	26.2 lbs	2.72
	DPL-10	10" Lid	2/125	23.2 lbs	1.83
Rectangle	DP-105*	10" x 5" Plate	4/125	20.2 lbs	0.93
	DPL-105	10" x 5" Lid	4/125	23.1 lbs	2.36
Round	PL-06*	6" Plate	8/125	15.4 lbs	1.08
	PL-07*	7" Plate	8/125	20.2 lbs	1.50
	PL-09*	9" Plate	4/125	18.0 lbs	1.43
	PL-10*	10" Plate	4/125	23.5 lbs	1.83
	PL-93*	9" Plate - 3 Section	4/125	18.0 lbs	1.39
	PL-11*	10" Plate - 3 Section	4/125	24.6 lbs	1.81
Platter	PL-16-1*	10¼" x 7¾" Platter	4/125	20.5 lbs	1.42
	PL-16-2*	12½" x 10" Platter	4/125	32.5 lbs	2.21



BPI Certified
Commercially Compostable
Product



Bowls & Lids



- A versatile option perfect for takeout, food trucks, catering events, weddings and more
- Molded fiber bowls are perfect green solution that is both compostable and disposable
- Bowl and lid combos allow for easy storage of leftovers
- PET lids are both disposable and recyclable
- Perfect for serving soups, salads and more

	Item	Description	Color	Pack	Weight	Cube
Oval	BB-20 *	20oz Bowl	○	4/125	18.1 lbs	1.21
	BB-24 *	24oz Bowl	○	2/125	12.5 lbs	1.01
	BB-32 *	32oz Bowl	○	2/125	15.7 lbs	1.51
	BBL-20	20oz Lid	⊗	4/125	8.4 lbs	2.80
	BBL-24	24oz Lid	⊗	2/125	7.2 lbs	1.71
	BBL-32	32oz Lid	⊗	2/125	7.3 lbs	2.51
Round	BL-12 *	12oz Bowl	○	8/125	23.5 lbs	2.01
	BL-16 *	16oz Bowl	○	8/125	28.0 lbs	2.82
Round, Tan	TB-32 *	32oz Bowl	●	4/75	18.0 lbs	1.61
	TBL-32	32oz Lid	⊗	4/75	14.7 lbs	2.56
Square	DP-12B *	12oz Bowl	○	4/125	12.5 lbs	0.71
	DPL-12B	12oz Lid	⊗	4/125	14.7 lbs	2.13
Square, Tan	DPT-24B	24oz Bowl	●	4/75	14.1 lbs	1.21
	DPT-32B	32oz Bowl	●	4/75	18.7 lbs	1.29
	DPT-40B	40oz Bowl	●	4/75	20.7 lbs	2.17
	DPL-2440	24oz, 32oz, 40oz Lid	⊗	4/75	10.4 lbs	3.03
Tub, Tan	TDC-79 *	Deep Tub 7" x 9" x 3 1/8"	●	4/50	18.3 lbs	2.02
	TSC-79 *	Shallow Tub 7" x 9" x 2 1/4"	●	4/50	13.8 lbs	1.77
	TCL-79 *	7" x 9" Fiber Lid	●	4/50	10.8 lbs	1.19
	TCL-PET-79	7" x 9" Lid	⊗	4/50	11.3 lbs	1.55

Trays



- Made from molded fiber or bagasse materials
- Compostable and disposable
- Perfect selection for eco-friendly option and foam alternative
- Perfect for cafeterias, using multiple compartments for serving sandwiches, nachos, sides, main dishes and more



	Item	Description	Color	Pack	Weight	Cube
Compartment	NT-79	3 Section Nacho	○	4/125	30.9 lbs	3.26
	TL-15 *	5 Section	○	4/125	32.4 lbs	2.01
	TL-15-T *	5 Section Value	○	4/125	26.9 lbs	1.77
	TL-16 *	6 Section	○	2/125	22.4 lbs	1.28
Fiber	TRAY-14D *	6 1/10" x 5.7" x 1 1/2"	●	4/125	20.9 lbs	1.30
	TRAY-14S *	6" x 6" x 7/8"	●	4/125	16.5 lbs	0.71
	TRAY-17S *	8 3/10" x 4 1/2" x 9/10"	●	4/125	18.7 lbs	1.09
	TRAY-2DP *	8 9/10" x 6 1/2" x 1"	●	4/125	25.4 lbs	2.04
	TRAY-2S *	8" x 5 3/4" x 9/10"	●	4/125	22.0 lbs	1.34
	TRAY-4D *	9 4/10" x 6 6/10" x 1 2/10"	●	2/125	18.2 lbs	1.29
	TRAY-104 *	10 1/4" x 4 4/10" x 1"	●	4/125	22.0 lbs	1.17



Index

1

1317-200A	143
10991	46
10992	46
10993	46
10994	46
11991	54
11992	54
11993	54
11994	54
12001	50
12002	50
12003	50
12004	50
12991	54
12992	54
12993	54
12994	54
13991	54
13992	54
13993	54
13994	54
14000	46
14001	46
14002	46
14003	46
14004	46
14005	46
14991	48
14992	48
14993	48
14994	48
17991	56
17992	56
17993	56
17994	56
18991	54
18992	54
18993	54
18994	54
18995	54

2

2KP505B02	12
2KS308B	12
2001	56
2002	56
2003	56
2004	56
20991	46
20992	46
20993	46
20994	46
20995	46
21991	50
21992	50
21993	50
21994	50
22991	54
22992	54
22993	54
22994	54
22995	54
23991	54
23992	54
23993	54
23994	54

24421A	100
26991	48
26992	48
26993	48
26994	48
27991	56
27992	56
27993	56
27994	56
28461A	100
28462A	100
28991	54
28992	54
28993	54
28994	54

3

3KP203B500	12
3KP203W06	12
3KP203W07	12
3KP203W500	12
3KP401B500	12
3KP505B	12
3KS308B01	12
3KS601B02	12
3KS601W05	12
3000	56
3001	56
3002	56
3003	56
3004	56
3991	48
3992	48
3993	48
3994	48
31991	50
31992	50
31993	50
31994	50
32991	42
32992	42
32993	42
32994	42
32995	42
34990	42
34991	42
34992	42
34993	42
34994	42
34995	42
35991	42
35992	42
35993	42
35994	42
35995	42
36991	42
36992	42
36993	42
36994	42
36995	42
37991	42
37992	42
37993	42
37994	42
37995	42
38991	42
38992	42
38993	42

38994	42
38995	42

4

4KP203B05	12
4KP203B09	12
4KP203W05	12
4KP203W06	12
4KP203W14	12
4KP405B	12
4KP505B01	12
4KS601B02	12
4991	48
4992	48
4993	48
4994	48
40991	46
40992	46
40993	46
40994	46
40995	46

5

5KP203B03	12
5KP203W02	12
5KP203W04	12
5KP405B	12
5KP505B	12
5KS308B03	12
5001	54
5002	54
5003	54
5004	54
5501	54
5502	54
5503	54
5504	54
5991	57
5992	57
5993	57
5994	57
50991	46
50992	46
50993	46
50994	46
50995	46

6

6KP203B	12
6KP203W	12
6KP302B	12
6KP302W	12
6KP405B	12
6KP505B	12
6KP505W	12
6KS308B	12
6KS308W	12
6KS601B	12
6KS601C01	12
6KS601W	12
6000	46
6001	46
6002	46
6003	46
6004	46
6501	46
6502	46
6503	46

6504	46
6991	56
6992	56
6993	56
6994	56
60991	46
60992	46
60993	46
60994	46
60995	46

7

7000	46
7001	46
7002	46
7003	46
7004	46
7005	46
7991	54
7992	54
7993	54
7994	54

8

8001	56
8002	56
8003	56
8004	56
8991	54
8992	54
8993	54
8994	54
82991	46
82992	46
82993	46
82994	46

9

9001	46
9002	46
9003	46
9004	46
9005	46
9991	56
9992	56
9993	56
9994	56
99001	57

A

ABS Heavyweight Knife	14
Airlaid Napkins	83
Allergy Marker	96
Aluminum Ashtrays	150
American Flag Picks	93
Anchor	52
Anchor PF	52
Apollo	56
Aprons	99
Arm Guards	101
Arrow Picks	93
AS1000AT	80
AS1000CT	80
AS1000GR	80
AS1000MX	80
AS1000OS	80
AS1000PG	80
AS1000RR	80

AS1000SP	80
AS1000ST	80
Ashtrays	150
ATB-CRAB	89
ATB-LOBS	89
ATB-WHITE	89
Atlantic	44, 46

B

B150150100	67
B175150100	67
B175190100	67
B225150050	67
B275165050	67
B275190050	67
B300095050	67
B300165050	67
B300165050B	67
B300165050G	67
B300165050P	67
B300165050Y	67
B300190050	67
B325215048	67
B450150040	67
Baby Wipes	144
Bag Rack	140
Bags	139
Baking Cups	145
Ball Picks	94
Bamboo Chopsticks	14
Bamboo Picks	94
Bamboo Skewers	96
Bamboo Stirrers	122
Bandit	53
Banquet Roll	150
Bath Mats	152
Bath Tissues	144
Bath Towels	144
BB-20	138
BB-24	138
BB-32	138
BBL-20	138
BBL-24	138
BBL-32	138
BC35-NRA	30
BC35-NRA-SQ	30
BC35PW	30
BC35PW-SQ	30
BC45-NRA	30
BC45-NRA-SQ	30
BC45PW-SQ	30
BC100BKL	71
BC100BKS	71
BC100NBL	71
BC100NBS	71
BC100WL	71
BC100WS	71
BCPW-F	13, 159
BCPW-K	13, 159
BCPW-S	13, 159
Beanie Caps	71
Beard Protectors	75
Beer Coasters	30
Beverage Napkins	84
BEVNAP1M-BK	84
BEVNAP1M-CB	84
BEVNAP1M-G	84
BEVNAP1M-N	84

BEVNAP1M-NB	84
BEVNAP1M-O	84
BEVNAP1M-PUR	84
BEVNAP1M-R	84
BEVNAP1M-W	84
BEVNAP1M-YEL	84
Bibs	89
BL-12	138
BL-16	138
Black Rhino	44, 46
Black Widow	44, 46
Blue Rhino	44, 46
BMPW	152
Bond Register Rolls	67
Bouffant Caps	76
Bowls	138, 164
BPB2135	18, 20
BPB2737	18, 19
BPWF-7	13, 159
BPWK-7	13, 159
BPWS-7	13, 159
BPWSS-7	13, 159
BR1225	67
BR1300	67
BR1325	67
BR1381	67
BR1441	67
BRC5280	18
BSF7	96
BSF10	96
Bun Pan Bags	18

C

C2 Hybrid	39, 40, 42
C175100100	64
C225085050	64
C225095050	64
C275095050	64
C300092050	64
C300095050	64
C325095048	64
C450080040	64
C3000650503P	64
CAC171	30
CACPW	30
Carbonless Register Rolls	64
Carriers	29
Catch All Coaster	30
Catch All Towel	143
CC-2CupTray	29, 161
CC-802	29, 161
CC-832	29, 161
CC-1232	29, 161
CCBFP21133	136
CCBHP13113	136
CCP-9-SQ	26, 161
CCP-12	26, 161
CCP-16	26, 161
CCP-20	26, 161
CCP-24	26, 161
CDL-1224	26, 161
CFCL-8	156, 127
CFCL-1232	156, 127
CFL-9	26, 161
CFL-1224	26, 161
Chafing Fuel	147
Chameleon	50
CHCL-8	28, 162



- CHCL-1020 28, 162
- Chef Hats 72
- Chop Holders 150
- CHTB221312 136
- Circle Beverage Plug 122
- CK125 80
- CL16N 126
- CL16PP 126
- CL16W 126
- CL32N 126
- CL32PP 126
- CL32W 126
- CL812N 126
- CL812PP 126
- CL812W 126
- Club Frill Picks 94
- Coasters 30
- Cocktail Parasols 94
- Cold Cups 25
- Compartment Microwaveable To Go Combo 130
- Compostable Food Containers 127, 156
- Corrugated Catering Boxes 135
- Corrugated Take Out Boxes 135
- CPB10 79
- CPC-2 134, 157
- CPC-4 134, 157
- CPC-325 134, 157
- CPCL-2 134, 157
- CPCL-34 134, 157
- CPLA Cutlery 13, 159
- CPLUG Beverage Plug 122
- CPW2P575 144
- CPW-F 13, 159
- CPW-K 13, 159
- CPW-S 13, 159
- CR2225 64
- CR2300 64
- CR20002PKP 79
- CR20004PKP 79
- CR21603PKP 79
- CR30004BK 79
- CR30006BKP 79
- Crayons 79
- CRH20004BXP 79
- CRH20004PKP 79
- CRH30006BKP 79
- CT652004B 68
- CT652018P 68
- CT652030BR 68
- CT652032P 68
- CT652039P 68
- CT652300B 68
- CT652300P 68
- CT652400P 68
- CT652500P 68
- CT652700BR 68
- CT652700P 68
- CT652900BR 68
- CT655118B 68
- CT657105P 68
- CT1252023B 68
- CT1252023BR 68
- CT1252023P 68
- CT1252027P 68
- CT1252030B 68
- CT1252030P 68
- CT1252031P 68

- CT1252200B 68
- CT1252200BR 68
- CT1252200P 68
- CT1255164P 68
- CTBL1163 136
- CTBM993 136
- CTBS962 136
- Cup Carriers 29, 161
- Cup Sleeves 30
- Cutlery 4, 159

D

- DA2442 100
- DA2836NW 100
- DA2836NWPL 100
- DA2846 100
- DA2846-4E 100
- DA3545-6PVCRE 100
- DA3545-6PVCRW 100
- DAK2442 100
- DAK2442B 100
- DAK2846 100
- DAK2846B 100
- DC08240C 131
- DC08480 131
- DC12240C 131
- DC16240C 131
- DC16480 131
- DC24240C 131
- DC32240C 131
- DC32480 131
- DCL0832 131
- Deli Container Combos 131
- Deli Container Lids 131
- Deli Containers 131
- DF16 34
- DHL-81 132
- DHL-83 132
- Diamond Towels 143
- Die Cut Handle Shopping Bag 139
- Dinner Napkins 83
- Dispenser Napkins 84
- Display Picks 94
- Disposable Bags 16
- Disposable Cold Cups 161
- Disposable Cups 24
- Disposable Hot Cups 162
- DNAP1M-BK 83
- DNAP1M-DC 83
- DNAP1M-PUR 83
- DNAP1M-R 83
- DNAP1M-T 83
- DNAP1M-W 83
- DNAP1M-YEL 83
- Doilies 90
- DP-10 137
- DP-12B 138
- DP-66 137
- DP-88 137
- DP-105 137
- DPL-10 137
- DPL-12B 138
- DPL-66 137
- DPL-88 137
- DPL-105 137
- DPL-2440 138
- D-PLA-18 132
- D-PLA-38 132

- DPT-24B 138
- DPT-32B 138
- DPT-40B 138

E

- Edge 52, 55
- Edge Black 44, 46
- Edge PF 52, 55
- Edge White 44, 46
- EFC10 34
- ES1000 30
- ES1000N 30
- Ethanol Gel Chafing Fuel 148
- Extra Heavy Weight Cutlery 10

F

- F86 33
- Face Masks 105
- FC-8 156, 127
- FC-12 156, 127
- FC-16 156, 127
- FC-32 156, 127
- FCH10-1 34
- FD18-8 34
- FD215 34
- FD235 34
- FD1575 34
- FD1778 34
- FD2178 34
- FE1113 33
- FE1221 33
- FE1418 33
- FE1422P 33
- FE1422W 33
- FE1521 33
- FE1718 33
- FE1820SP 33
- FE2019 33
- FE2425 33
- FE121438P 33
- FE141634 33
- FE145205 33
- Fiber Portion Cups 157
- Filter Cone Holder 34
- Filter Cones 34
- Filter Discs 34
- Filter Envelopes 33
- Filter Sheets 34
- Fingerbowl 90
- First Aid Towelette 90
- Flag Picks 93
- Flat Bamboo Skewers 96
- Flat Bottom T-Shirt Bag 139
- Flex Straw 120
- Flushable Wipes 144
- Flushcare Flushable Wipes 144
- Folded Take Out Boxes 128
- Food Container/Lid Combos 126
- Foodguard 48
- Foodguard XP 48
- Food Rotation Labels 22
- Food Service Towels 143
- Food Shells 149
- Food Storage Bags 19
- Frill Picks 94
- FRL23500 22
- Fry Oil Filter Papers 33
- Fry Oil Filtration 32

FS1	33
FS1217-100	34
FS1218P	34
FS1222	34
FS1321	34
FS1430H	34
FS1625	34
FS1638	34
FS1728	34
FS2430	34
FS12235	34
FS13524	34
FS15215	34
FS111820	34
FS112258	34
FS147823	34
FS195275	34
FS213325	34
FS11751175	34
FSHD69	19
FSHD1014	19
FSHD1824	19
FSLD48	20
FSLD69	20
FSLD615	20
FSLD818	20
FSLD1014	20
FSLD1024	20
FSLD1824	20
FTB1BK	128
FTB1N	128
FTB1W	128
FTB2BK	128
FTB2N	128
FTB2W	128
FTB3BK	128
FTB3N	128
FTB3W	128
FTB4BK	128
FTB4N	128
FTB4W	128
FTB5BK	128
FTB5N	128
FTB5W	128
FTB8BK	128
FTB8N	128
FTB8W	128
FTKRMF	144
FTS66	19
FTS77	20
FTWRCF	144

G

GC1A-2	63
GC11A-3	63
GC12A-2	63
GC101-2	63
GC501-1	62
GC503-1	62
GC1200-1	62
GC3516-1	62
GC3616-1	62
GC3616WP-1	62
GC3632-1	62
GC3674-1	62
GC4700WP-2	63
GC4774-1B	62
GC4797-2	63

GC4797-2B	63
GC4797-3B	63
GC4900-2	63
GC4900-2B	63
GC4932-1	62
GC4997-2	63
GC4997-2B	63
GC4997-3	63
GC6000-2	63
GC6932-1	62
GC7000-2	63
GCKDUP-1	62
GCKIT	113
GCP3632-1	62
GCT4797-2	63
GCT4797-2B	63
GE2H72	148
Giant Poly Straws	118
Gladiator	50
Gladiator - PF	50
Glove Dispensers	57
Gloves	38
GP4H24	148
GP6H24	148
Gracias Bag	140
Grape Grip	45, 46
Grill Brick	113
Grill Cleaning	113
Grill Pad Holders	113
Grill Pads	113
Grill Pad/Screen Kits	113
Grill Screens	113
GS483	113
GS484	113
GS508	113
GS1020	113
GS2025	113
GS4100	113
Guest Checks	60

H

Hairnet Dispensers	74
Hairnets	73
Hair Restraints	70
HC-4	28, 162
HC-8	28, 162
HC-10	28, 162
HC-12	28, 162
HC-16	28, 162
HC-20	28, 162
HCL-1220	28, 162
Headwear	70
High Density Food Storage Bags	19
High Heat Oven Bags	18
High Heat Pan Liners	18
Hinged Lid Containers	132, 155
HL-66	132
HL-81	132
HL-83	132
HL-91	132
HL-93	132
HL-96	132
HL-96-2	132
Honeycomb Hairnets	73
Hot Cup Lids	28, 162
Hot Cups	27
Hotel & Motel Products	151
HP918	33

HP1320-100	33
HS1415	33
HW Polypropylene Cutlery	7
HW Polystyrene Cutlery	8
HW Polystyrene Retail Box	9
Hybrid Gloves	39

I

Ink Ribbons	68
Invisible Hairnets	73
Isolation Gowns	106
ISONW-E	106
ISONWP-W	106
ISONW-W	106
ISONW-Y	106
ISOPE-E	106
ISOPE-EXL	106
ISOPE-W	106
Italian Flag Picks	93

J

Jumbo Poly Straws	119
-------------------	-----

K

KABS1000	14
KCT250IT	80
KCT250JF	80
KCT250MT	80
Keyguard Arm Guards	101
Keyguard Lab Coats	103
KFDF14	34
Kid's Bibs	79
Kid's Cups	80
Kid's Kaps	79
Kid's Placemats	80
Kids' products	78
Knot Picks	94

L

L5PG	149
L7EP	149
L102P	149
L103P	149
LA200P	150
LA201P	150
Lab Coats	103
Latex Gloves	55
LC0-EKG-2X	103
LC0-EKG-3X	103
LC0-EKG-4X	103
LC0-EKG-5X	103
LC0-EKG-L	103
LC0-EKG-M	103
LC0-EKG-S	103
LC0-EKG-XL	103
LC0-ENW-2X	104
LC0-ENW-3X	104
LC0-ENW-4X	104
LC0-ENW-5X	104
LC0-ENW-B2X	104
LC0-ENW-B3X	104
LC0-ENW-B4X	104
LC0-ENW-B5X	104
LC0-ENW-BL	104
LC0-ENW-BM	104
LC0-ENW-BS	104
LC0-ENW-BXL	104



Index

LC0-ENWHD-2X 104
 LC0-ENWHD-3X 104
 LC0-ENWHD-4X 104
 LC0-ENWHD-5X 104
 LC0-ENWHD-L 104
 LC0-ENWHD-M 104
 LC0-ENWHD-S 104
 LC0-ENWHD-XL 104
 LC0-ENW-L 104
 LC0-ENW-M 104
 LC0-ENW-S 104
 LC0-ENW-XL 104
 LC0-ESMS-2X 104
 LC0-ESMS-3X 104
 LC0-ESMS-4X 104
 LC0-ESMS-5X 104
 LC0-ESMS-L 104
 LC0-ESMS-M 104
 LC0-ESMS-S 104
 LC0-ESMS-XL 104
 LD4 90
 LD5 90
 LD6 90
 LD7 90
 LD8 90
 LD9 90
 LD10 90
 LD12 90
 LD14 90
 LD16 90
 LD18 90
 LDRMB1000A 22
 LDRMB1000CL 22
 Lemon Wedge Bags 149
 Lemon Wraps 149
 LN1414-F 83
 LN1517-8 83
 LN1616-F 83
 LN1717-8 83
 Low Density Food Storage Bags 20
 LT1217-6 83

M

Meal Kits 11
 Med-Edge 45, 46, 52
 Medium Heavy Weight Cutlery 6
 Medium Rare Steak Markers 96
 Medium Steak Markers 96
 Medium Weight Cutlery 5
 Medium Weight Towels 143
 Medium Well Steak Markers 96
 Metal Sponges 112
 Mexican Flag Picks 93
 MF312-100 34
 MFP22 35
 MFP40 35
 Microwavable To Go Containers 129
 Miracle Fry Powder 35
 Miscellaneous 147
 Motel Products 151
 Multilingual Take Out Bags 139
 Multi-Part Guest Checks 63

N

Napkin Bands 85
 Napkins 82
 NB10000B 85
 NB10000BK 85

NB10000BL 85
 NB10000G 85
 NB10000R 85
 NB10000W 85
 Neptune 57
 Ninja 56
 Nitra-Flex 45, 46
 Nitrile Gloves 43
 NK1P99 84
 NK1P1113 84
 NK1P1312 84
 NK1P1517 83
 NK1P1717 83
 NK2P865 84
 NK2P1010BK 84
 NK2P1517 83
 NK2P1717 83
 NK3P1717 83
 NKA1P1516 83
 NKR2P865 84
 Non-Pleated Bouffant Caps 76
 NT-79 138

O

Odyssey 53
 Odyssey PF 53
 OPL1215 18
 OPL1515 18
 OPL1820 18
 OPL1914 18
 OPL2028 18
 OPL2314 18
 OPL3412 18
 OPL3418 18
 ORB1824 18
 ORB2418 18
 ORB3426 18
 Oven Bags 18

P

P1203B 5
 P1203FB 5
 P1203FW 5
 P1203W 5
 P1405B 6
 P1405FB 6
 P1405FW 6
 P1405W 6
 P1505B 7
 P1505FB 7
 P1505FW 7
 P1505W 7
 P2103W 14
 P2203B 5
 P2203FB 5
 P2203FW 5
 P2203W 5
 P2303FB 14
 P2303W 14
 P2405B 6
 P2405FB 6
 P2405FW 6
 P2405W 6
 P2505B 7
 P2505FB 7
 P2505FW 7
 P2505W 7
 P3203B 5

P3203FB 5
 P3203FW 5
 P3203W 5
 P3405B 6
 P3405FB 6
 P3405FW 6
 P3405W 6
 P3505B 7
 P3505FB 7
 P3505FW 7
 P3505W 7
 P4203B 5
 P4203FB 5
 P4203FW 5
 P4203W 5
 P4405B 6
 P4405FB 6
 P4405FW 6
 P4405W 6
 P4505B 7
 P4505FB 7
 P4505FW 7
 P4505W 7
 P5203FB 5
 P5203FW 5
 P5203W 5
 Pacific 45, 46
 Paddle Picks 94
 Pan Liners 18
 Paper Bibs 89
 Paper Caps 72
 Paper Chef Hats 72
 Paper Cold Cup Lids 26
 Paper Cold Cups 26
 Paper Food Containers 125
 Paper Hot Cups 28, 162
 Paper Straws 121, 160
 Paradigm 53
 Party Picks 94
 PB24 89
 PB25 89
 PBW 89
 PC-02 134, 157
 PCC12 26
 PCC16 26
 PCC22 26
 PCCLS1222 26
 PCL-02 134, 157
 PCLT1 134
 PCLT2 134
 PCLTL 134
 PCP100C 134
 PCP150B 134
 PCP150C 134
 PCP200B 134
 PCP200C 134
 PCP250B 134
 PCP325B 134
 PCP325C 134
 PCP400B 134
 PCP400C 134
 PET Cold Cup Lids 25
 PET Cold Cups 25
 PFC8N 126
 PFC8NCOM 126
 PFC8W 126
 PFC8WCOM 126



RP110NW28.....	76	RPAG-500BS.....	101	RR7225SP.....	65
RP110NWA.....	76	RPBWS-80.....	144	RR7313.....	66
RP110NWA24.....	76	RPBWSR-80.....	144	RR8313.....	66
RP110NWB.....	76	RPBWU-80.....	144	RSBR.....	20
RP110NWB19.....	76	RPBWUR-80.....	144	RSC150BK-NS.....	102
RP110NWB24.....	76	RPDB-SH.....	112	RSC150-NS.....	102
RP110NWBWP.....	76	RPF325RD.....	14	RSC150-NSXL.....	102
RP110NWC.....	76	RPFM-ELE.....	105	RSC150W-NS.....	102
RP110NWC5.....	76	RPFM-ELE-W.....	105	RSC150W-WNS.....	102
RP110NWC19.....	76	RPH100B21.....	74	RSCCLP-150.....	102
RP110NWC24.....	76	RPH100B24.....	74	RSCCLP-150E.....	102
RP110NWC519.....	76	RPH100BK.....	74	RSCCLP-150EXL.....	102
RP110NWNB.....	76	RPH100BK21.....	74	RSCCLP-150XL.....	102
RP110NWNB24.....	76	RPH100BK24.....	74	RSCSS-150E.....	102
RP110NWO.....	76	RPH100BR21.....	74	RSCSS-150EXL.....	102
RP110NWO24.....	76	RPH100BR24.....	74	RSCSS-150W.....	102
RP110NWP.....	76	RPH100DB.....	74	RSCSS-150WXL.....	102
RP110NWY.....	76	RPH100W.....	74	RTKR350.....	144
RP110NWY24.....	76	RPH100W21.....	74	RTKR600.....	144
RP110PE5.....	76	RPH100W24.....	74	RTS3000.....	14
RP112-35.....	146	RPH100W26.....	74	RTWR600.....	144
RP114-3.....	146	RPH144HD.....	74	Rubber Gloves.....	57
RP144.....	94	RPH144HD25.....	74	RW4H24.....	148
RP145A.....	96	RPH144HDBK.....	74	RW6H24.....	148
RP145A5.....	96	RPH144HDBK25.....	74	RWGD1.....	57
RP145B.....	96	RPH144LTBK.....	74		
RP145B5.....	96	RPH144LTBK28.....	74		
RP145C.....	96	RPH144LTDB.....	74		
RP145C5.....	96	RPH144LTDB28.....	74		
RP145D.....	96	RPH144LTLB.....	74		
RP145D5.....	96	RPH144LTLB28.....	74		
RP145E.....	96	RPH144LTW.....	74		
RP145E5.....	96	RPH144LTW28.....	74		
RP145WA.....	96	RPHDL.....	74		
RP145WB.....	96	RPHDM.....	74		
RP145WC.....	96	RPHDS.....	74		
RP145WD.....	96	RPOS1.....	72		
RP145WE.....	96	RPOS1A.....	72		
RP146.....	96	RPOS1W.....	72		
RP147.....	93	RPPBB6.....	140		
RP147-45.....	93	RPPH100.....	105		
RP147-45BK.....	93	RPPWB6.....	140		
RP147BK.....	93	RPPWB10.....	140		
RP148.....	93	RPS1M.....	134		
RP148BK.....	93	RPS1MT.....	134		
RP148P.....	93	RPSH1000.....	134		
RP148PBK.....	93	RPST2M.....	134		
RP149-4BK.....	93	RPTYB6.....	140		
RP149-4C.....	93	RPTYB6FS.....	140		
RP149-6BK.....	93	RPTYB6G.....	140		
RP149-6C.....	93	RPTYB6HW.....	140		
RP200-45.....	146	RPTYB6V.....	140		
RP200-55.....	146	RPTYB8.....	140		
RP214-6.....	146	RPVCAG6-144B.....	101		
RP8541.....	112	RPVCAG6-144W.....	101		
RP8542.....	112	RPWB1918HD.....	139		
RP8543.....	112	RPWB1919.....	140		
RP11490.....	143	RR1225.....	67		
RP11550.....	143	RR1300.....	67		
RP11553.....	143	RR1325.....	67		
RP11555.....	143	RR1381.....	67		
RPA20.....	100	RR1441.....	67		
RPA20-15.....	100	RR1450.....	67		
RPA20HW.....	100	RR2225.....	64		
RPAG-100NWP.....	101	RR2300.....	64		
RPAG-500.....	101	RR2450.....	64		
RPAG-500B.....	101	RR7225.....	65		

S

S460.....	113
S460/20.....	113
S490.....	109
S601RPC.....	9
S610.....	111
S630C/20.....	111
S724.....	112
S730.....	112
S730/6.....	112
S730BX.....	112
S740.....	111
S740C/20.....	111
S775.....	112
S775/6.....	112
S775BX.....	112
S860.....	110
S860/20.....	110
S880.....	110
S880/20.....	110
S880-610.....	110
S903.....	109
S960.....	110
S960/20.....	110
S965.....	110
S980.....	110
S1012.....	112
S1308B.....	6
S1308FB.....	6
S1308FW.....	6
S1308W.....	6
S1525.....	120
S1525A.....	120
S1525A7.....	120
S1525BK.....	120
S1525BK7.....	120
S1601B.....	8
S1601C.....	8
S1601CH.....	8
S1601FB.....	8
S1601FW.....	8
S1601W.....	8

S1601XC	9	S4603FB	10	STNGT2290919	118
S1601XCH	9	S12001FB	14	STNGT2290926	118
S1601XW	9	S42001FB	14	STNGT2601001	118
S1602B	10	S64001FB	14	STNGT2601002	118
S1602CH	10	Saddle Bags	20	STNGT2601003	118
S1602W	10	Sanitary Bags	152	STNGT2601008	118
S1603B	10	SB55	20	STNGT3051203	118
S1603C	10	SB67	20	STNGTL2601001	121, 160
S1603CH	10	SB85	20	STNGTL2601002	121, 160
S1603FB	10	SB85DP	20	STNGTP1970701	121, 160
S1603W	10	SB1085	20	STNGTP2601001	121, 160
S2303W	14	SB1085DPZ	20	STNGTP2601002	121, 160
S2308B	6	SCH7	72	STNGTP2601003	121, 160
S2308FB	6	SCH9	72	STNJM1460501	119
S2308FW	6	SCH10	72	STNJM1460502	119
S2308W	6	SCH12	72	STNJM1460503	119
S2601B	8	Scouring Pads	108	STNJM1460504	119
S2601C	8	Screw-N-Lock Pad Holder	112	STNJM1520602	119
S2601CH	8	Scrubbing Pad/Sponge Combos	111	STNJM1970703	119
S2601FB	8	Seat Bands	152	STNJM1970704	119
S2601FW	8	Sensi-Flex	52	STNJM1970711	119
S2601W	8	Sentinel	53	STNJM1970712	119
S2601XC	9	Serving Utensils	14	STNJM1970713	119
S2601XCH	9	Shoe Covers	102	STNJM1970714	119
S2601XW	9	Shopping Bag	139	STNJM1970720	119
S2602B	10	Shower Slippers	152	STNJM1970721	119
S2602CH	10	Silverware Bag	20	STNJM1970725	119
S2602W	10	Single Part Guest Checks	62	STNJM1970733	119
S2603C	10	Sip Straws	120	STNJM1970750	119
S2603FB	10	Skewers	95	STNJM1970763	119
S2603W	10	Slice Holder	134	STNJM1970774	119
S3308B	6	Slippers	152	STNJM2290901	119
S3308FB	6	Soap Pads	112	STNJM2290903	119
S3308FW	6	Solid Color Placemats	87	STNJM2410904	119
S3308W	6	Soup Pan Liners	18	STNJM2601003	119
S3601B	8	Specialty Cutlery	14	STNJM2601004	119
S3601C	8	SPL1215	18	STNJM2601005	119
S3601CH	8	SPL1814	18	STNJM2601006	119
S3601FB	8	SPL2417	18	STNJM2601007	119
S3601FW	8	SPL3425	18	STNJM2601008	119
S3601W	8	SPM914A	87	STNJM2601011	119
S3601XC	9	SPM914BK	87	STNJM2601015	119
S3601XCH	9	SPM914C	87	STNJM2601024	119
S3601XW	9	SPM914DC	87	STNJM3051206	119
S3602B	10	SPM914E	87	STNJM6092401	119
S3602CH	10	SPM914G	87	STNJML1970701	121, 160
S3602W	10	SPM914N	87	STNJML1970702	121, 160
S3603B	10	SPM914P	87	STNJMP1970701	121, 160
S3603C	10	SPM914Q	87	STNJMP1970702	121, 160
S3603CH	10	Steak Markers	96	STNJMP1970703	121, 160
S3603FB	10	Steam Pan Liners	18	STNJMP1970704	121, 160
S3603W	10	Stir N Plug	122	STNJMP1970705	121, 160
S4308B	6	Stirrers	122	STNJMP1970706	121, 160
S4308FB	6	StirStix	122	STNJMP1970707	121, 160
S4308W	6	STNGT1400502	118	STNSJ1970701	118
S4601B	8	STNGT1400503	118	STNSJ1970704	118
S4601C	8	STNGT1970703	118	STNSJ1970705	118
S4601CH	8	STNGT1970704	118	STNSJ1970710	118
S4601FB	8	STNGT1970705	118	STNSJ2601012	118
S4601FW	8	STNGT1970708	118	STNSL1460501	120
S4601W	8	STNGT1970721	118	STNSL1780704	120
S4601XC	9	STNGT1970722	118	STNSLP1460501	121, 160
S4601XCH	9	STNGT2160819	118	STNST1270501	120
S4601XW	9	STNGT2290904	118	STNST1270503	120
S4602B	10	STNGT2290905	118	STNST1400501	120
S4602FB	10	STNGT2290906	118	STNST1780700	120
S4603B	10	STNGT2290909	118	STNST1780701	120



Index

STNST1780705..... 120
 Straws..... 160
 Straws & Stirrers..... 117
 STSGT2601007..... 118
 STXJM1970710..... 120
 SW2H24..... 148
 SW4H24..... 148
 SW6H24..... 148
 SWB310..... 20
 Sword Picks..... 93
 SXH12001FB..... 14
 SXH64001FB..... 14
 Synthetic Gloves..... 49

T

T150150100..... 65
 T175200050..... 65
 T225040032..... 65
 T225056050..... 65
 T225064050..... 65
 T225074012..... 65
 T225074050..... 65
 T225080012..... 65
 T225080024..... 65
 T225080048..... 65
 T225080072..... 65
 T225095024..... 65
 T225150024..... 65
 T225165050..... 65
 T225200024..... 65
 T225200050..... 65
 T225218050..... 65
 T225250050..... 65
 T232200024..... 65
 T232400012..... 65
 T232435012..... 65
 T234400012CSI..... 65
 T238850012..... 66
 T244240024..... 66
 T300200050..... 66
 T318095024..... 66
 T318119048..... 66
 T318150050..... 66
 T318230050..... 66
 T318230050B..... 66
 T318230050G..... 66
 T318230050P..... 66
 T318230050Y..... 66
 T318273050..... 66
 T323085050CSI..... 66
 T323125050CSI..... 66
 T431095024..... 66
 T431135024..... 66
 T438065024..... 66
 T438315024..... 66
 Tableware..... 137, 163
 Take Out Bags..... 139
 Take Out Packaging..... 124
 TB-32..... 138
 TBDC85HD..... 139
 TBDC1210HD..... 139
 TBFB1110HD..... 139
 TBL-32..... 138
 TBRH1410HD..... 139
 TBRH1910HD..... 139
 TBRH2214HD..... 139
 TCD..... 150
 TCE14..... 25

TCE16..... 25
 TCE20..... 25
 TCE24..... 25
 TCEL1424..... 25
 TCL-79..... 138
 TCL-PET-79..... 138
 TDC-79..... 138
 TGC2CS32B..... 130
 TGC3CR33B..... 130
 TGC3CS33B..... 130
 TGCR16B..... 130
 TGCR24B..... 130
 TGCR32B..... 130
 TGCR38B..... 130
 TGCR48B..... 130
 TGCS12B..... 146
 TGCS24B..... 146
 TGCS28B..... 146
 TH225275012CSI..... 65
 TH225675008..... 65
 TH318160050..... 66
 TH318195050..... 66
 TH318480008..... 66
 TH318480008CSI..... 66
 TH318600004..... 66
 TH318870008..... 66
 TH318870008CSI..... 66
 Thank You Bag..... 140
 Thermal Register Rolls..... 65, 66
 Tissues..... 144
 TL-15..... 138
 TL-15-T..... 138
 TL-16..... 138
 Toilet Seat Bands..... 152
 Toothpicks..... 94
 Towelettes..... 90
 Towels..... 142
 TR2P0800..... 144
 TR2P1000..... 144
 TR7225..... 65
 TR7225SP..... 65
 TR7313..... 66
 TR7441..... 65
 TRAY-2DP..... 138, 164
 TRAY-2S..... 138, 164
 TRAY-4D..... 138, 164
 TRAY-14D..... 138, 164
 TRAY-14S..... 138, 164
 TRAY-17S..... 138, 164
 TRAY-104..... 138, 164
 Trays..... 138, 164
 TSC-79..... 138
 T-Shirt Bag..... 139
 Tuff-Skin..... 55
 Tulip Cups..... 145

U

Ultimate Fingerbowl..... 90
 Ultra-Flex..... 56
 Utility Pad Holder..... 112
 Utility Pads..... 112

V

V21A..... 150
 VCH8S..... 72
 VCH9..... 72
 VCH12..... 72
 Vented Food Container Lids..... 126

Vinyl Basket..... 150
 Vinyl Gloves..... 51
 Viscose Chef Hats..... 72
 VON4100..... 144
 VON5022..... 144

W

W0912..... 144
 W1014..... 88
 W1014E..... 88
 W1216S..... 88
 W1419S..... 88
 Waste Basket Liners..... 152
 Water Glass Bags..... 152
 Wave Top Handle Shopping Bag..... 139
 Wave Top To Go Bag..... 140
 WCPW-KIT..... 13, 159
 Well Steak Markers..... 96
 WF0911..... 144
 WF1000..... 13
 W-HC-8..... 28, 162
 W-HC-12..... 28, 162
 W-HC-16..... 28, 162
 W-HC-20..... 28, 162
 Wheat Cutlery..... 13
 White Placemats..... 88
 White Traymats..... 88
 Wick Chafing Fuel..... 148
 Wipe Out Sponge..... 112
 Wipes..... 90
 WK1000..... 13
 Wobble Wedges..... 150
 Wood Cutlery..... 13
 Wooden Skewers..... 95
 Wooden Steak Markers..... 96
 Wood Sandwich Picks..... 94
 Wood Stirrers..... 122
 WP1601..... 13
 WP2601..... 13
 WP3601..... 13
 WP4601..... 13
 WS1000..... 13
 WSS914..... 88
 WWSBK1230..... 150

Y

Yellow Rubber Gloves..... 57

Z

ZBG1011..... 20
 ZBG1315..... 20
 ZBQ78..... 20
 ZBS66..... 20
 Zip-it..... 20



